

3연동 단조데코 도어



대성-353F
MQ808[7] + 단조패턴694



대성-353F
퍼플월넛[8] + 단조패턴695



대성-353F
MQ808[7] + 단조패턴697



대성-353F
펄백색[5] + 단조패턴698

• 단조데코의 다양하고 섬세한 디자인으로 공간을 더욱 고급스럽고 품격있게 변화시킵니다



대성-353F
워시베이지(US201) [54] +단조패턴699



대성-353F
소마오크 [58] +단조패턴700



대성-353F
FZ805 [74] +단조패턴677



대성-353F
FZ805 [74] +단조패턴419

인테리어도어

ABS도어

에펠도어

플라스틱도어

슬라이딩도어

3계열도어

하키도어

3연동 단조데코 도어



대성-353F
902월넛[80]+단조패턴678



대성-353F
0901연월넛(티크)[78]+단조패턴679



대성-353F
브라운월넛[77]+단조패턴418



대성-353F
퍼플월넛[81]+단조패턴680

3연동 단조데코 도어



대성-353F
펄백색[51]+단조패턴703+싸틴투명



대성-353F
실버프렌치[57]+단조패턴708+아쿠아



대성-353F
크림티크[55]+단조패턴704+마스터라인(세로)



대성-353F
스무스오크[53]+단조패턴707+아쿠아

3연동 UV유리 도어



NEW

대성-353U 매화
펄백색[5] +싸틴투명

• 대성UV3연동은 판유리에 특수안료를 사용하여 3D기법으로 인쇄한 후, UV자외선으로 건조하여 페어유리로 마감한 제품으로 다양한 색상과 이미지 연출이 가능합니다



NEW

대성-353U 크로코스
스무스오크[53]+싸틴투명



NEW

대성-353U 베네치아
워시베이지(US201)[54]+아쿠아



NEW

대성-353U 플랜트
브룩시더[56]+아쿠아



NEW

대성-353U 꽃선반
아카시아[73]+싸틴투명

인테리어도어

ABS도어

에펠도어

글라스도어

슬라이딩도어

3연동도어

하프웨이

3연동 UV유리 도어



대성-353U 예시카
아카시아 [73] +아쿠아



대성-353U 설레임
워시베이지(US201) [54] +레인에스(세로)



대성-353U 클라리
다크티크 [79] +마스터라인(세로)



대성-353U 센나
MQ808 [71]

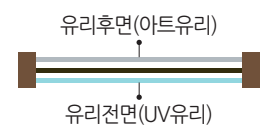

• 대성UV3연동은 판유리에 특수안료를 사용하여 3D기법으로 인쇄한 후, UV자외선으로 건조하여 페어유리로 마감한 제품으로 다양한 색상과 이미지 연출이 가능합니다



대성-353U 아리아나
아카시아 [73]



대성-353U 벤지
퍼플월넛 [8]



대성-353U 카트리나
FZ805 [74]



대성-353U 에밀리
워시베이지(US201) [54]

인테리어도어

ABS도어

에펠도어

글라스도어

슬라이딩도어

3연동도어

하키웨이

3연동 UV유리 도어



대성-353U 버사
펄백색 [51]



대성-353U 위즌
소마오크 [58]



대성-353U 디글
크림펠 [52]



대성-353U 루퍼스
워시베이지(US201) [54]

• 대성UV3연동은 판유리에 특수안료를 사용하여 3D기법으로 인쇄한 후, UV자외선으로 건조하여 페어유리로 마감한 제품으로 다양한 색상과 이미지 연출이 가능합니다



대성-353U 속삭임
소마오크 58



대성-353U 그린나래
워시베이지(US201) 54



대성-353U 퍼시
MQ808 71



대성-353U 예그리나
워시베이지(US201) 54

인테리어도어

ABS도어

에펠도어

글라스도어

슬라이딩도어

3연동도어

하키웨이

3연동 UV유리 도어



대성-353U 장미
다크티크 79



대성-353U 한나
펄백색 51



대성-353U 로덤
MQ808 71



대성-353U 미스티
아카시아 73

• 대성UV3연동은 판유리에 특수안료를 사용하여 3D기법으로 인쇄한 후, UV자외선으로 건조하여 페어유리로 마감한 제품으로 다양한 색상과 이미지 연출이 가능합니다



대성-353U 그로브
아카시아 [73]



대성-353U 자목련
펄백색 [51]



대성-353U 필러
크림티크 [55]



대성-353U 채플린
브룩시더 [56]

인테리어 도어

ABS 도어

에펠도어

글라스도어

슬라이딩도어

3면연동도어

하늬웨이

3연동 UV유리 도어

NEW

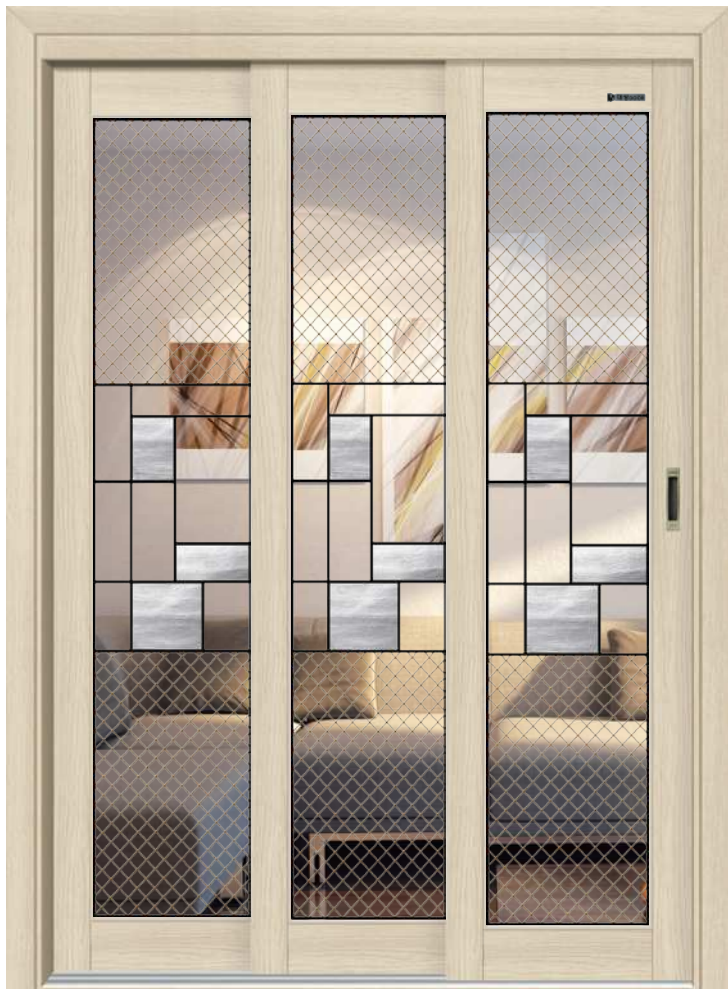

대성-353U 미로망입
스무스오크 53



미로망입(UV인쇄)

NEW



대성-353U 오리온망입
실버프렌치 57

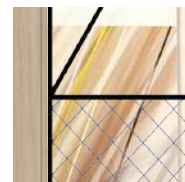

오리온망입(UV인쇄)

• 대성UV3연동은 판유리에 특수안료를 사용하여 3D기법으로 인쇄한 후, UV자외선으로 건조하여 페어유리로 마감한 제품으로 다양한 색상과 이미지 연출이 가능합니다



대성-353U 그린망입
펄백색 [51]



대성-353U 블루망입 (기본고시)
FZ805 [74]



그린(UV인쇄)



블루(UV인쇄)



레드(UV인쇄)



골드(UV인쇄)



대성-353U 레드망입 (하단고시)
워시베이지(US201) [54]



대성-353U 골드망입 (1/2고시)
새들브라운 [90]

3연동 망입유리 도어



대성-353M (1/2고시)
새들브라운 90 + 투명망입



대성-353M
실버프렌치[57]+투명망입



대성-353M (기본고시)
펄백색[51]+투명망입



투명망입



불투명망입



대성-353M (하단고시)
워시베이지(US201)[54]+투명망입



대성-353M (중앙고시)
민트색[88]+투명망입

NEW

인테리어도어

ABS도어

에펠도어

글라스도어

슬라이딩도어

3계열도어

하키웨이

3연동 아트유리 도어

NEW



대성-353W (중앙고시)
워시베이지(US201)54+아쿠아+마스터라인(가로)

NEW



대성-353W (중앙고시)
브룩시데56+워터큐브+투명망입

NEW



대성-353W (중앙고시)
실버프렌치57+투명망입+싸틴브론즈

NEW



대성-353W (중앙고시)
회색91+다이아몬드+볼투명망입

• 다양한 아트유리와 디테일한 질감의 디자인으로 고급스러운 아름다움이 한층 더해집니다



대성-353A
워시베이지(US201)54 +싸틴투명



대성-353A (기본고시)
크림펠52 +싸틴브론즈



대성-353A (하단고시)
아카시아73 +나뭇잎



대성-353A (1/2고시)
브룩시더56 +다이아몬드

인테리어도어

ABS도어

에펠도어

글라스도어

슬라이딩도어

3계열도어

하키웨이

3연동 아트유리 도어



대성-353A
브라운월넛[77]+위터큐브



대성-353A (기본고시)
아카시아[73]+고방



대성-353A (하단고시)
FZ805[74]+레인에스(세로)



대성-353A (1/2고시)
0901연월넛(티크)[78]+마스터라인(세로)

3연동 소노유리 도어



대성-353S 소노버티컬
6405흑단 82

• 대성 소노유리 3연동은 심플하고 절제된 디자인으로 어느 공간에도 품격을 더해줍니다



대성-353S 소노교차
MQ808 [71]



대성-353S 소노버티컬
6405흑단 [82]



대성-353S 소노난초
브라운월넛 [77]



대성-353S 소노하프
소마오크 [58]

인테리어도어

ABS도어

에펠도어

글라스도어

슬라이딩도어

3연동도어

하키웨이

3연동 소노유리 도어



대성-353S 소노사다리
아카시아 73



대성-353S 소노블록
워시베이지(US201) 54



대성-353S 소노매직스틱
MQ808 71



대성-353S 소노오벌레스
펄백색 51

• 대성 소노유리 3연동은 심플하고 절제된 디자인으로 어느 공간에도 품격을 더해줍니다



대성-353S 소노가든
스무스오크[53]

NEW



대성-353S 소노장미
실버프렌치[57]

NEW



대성-353S 소노튠립
실버프렌치[57]



대성-353S 소노산수화
스무스오크[53]

인테리어도어

ABS도어

에펠도어

글라스도어

슬라이딩도어

3연동도어

하키웨이

3연동 전통문살 도어

NEW



대성-353 TR
6405흑단 [82] +한지아크릴



대성-353 TK
워시베이지(US201) [54]

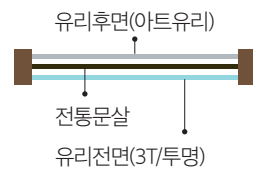
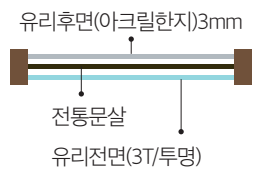

• 대성의 3연동 전통문살 도어는 다양한 문살 디자인과 고풍스러운 아름다움을 한층 살린 연동 도어입니다



대성-353 TG
브룩시더[56]



대성-353 TH
MQ808[71]



대성-353 TI (하단고시)
브라운월넛[77]+아쿠아



대성-353 TO
크림티크[55]+한지아크릴

인테리어 도어

ABS 도어

에펠도어

글라스도어

슬라이딩도어

3연동도어

하키웨이

3연동 보석유리 도어



NEW

대성-353C 발렌타인

스무스오크 53

• 대성 보석 3연동은 섬세하고 반짝이는 유리알이 다양하게 디자인되어 고급스럽고 아름다운 공간을 연출합니다

NEW



대성-353C 포피
아카시아 73



대성-353C 마사
워시베이지(US201) 54

3연동 보석유리 도어



대성-353C 프레스토
펄백색[51]



대성-353C 블로섬
브라운월넛[77]



대성-353C 노블
MQ808[71]



대성-353C 도리안
브라운월넛[77]

• 대성 보석 3연동은 섬세하고 반짝이는 유리알이 다양하게 디자인되어 고급스럽고 아름다운 공간을 연출합니다



대성-353C 조이
아카시아 73



대성-353C 모니카
워시베이지(US201) 54

인테리어도어

ABS도어

에펠도어

글라스도어

슬라이딩도어

3연동도어

하프웨이

3연동 보석유리 도어



대성-353C 마티나
소마오크 58



대성-353C 오피리아
펄백색 51

• 대성 보석 3연동은 섬세하고 반짝이는 유리알이 다양하게 디자인되어 고급스럽고 아름다운 공간을 연출합니다



대성-353C 베스
펄백색[5]



대성-353C 베이
브라운월넛[7]



대성-353C 이자벨
아카시아[73]



대성-353C 도로시
902월넛[80]

인테리어도어

ABS도어

에펠도어

글라스도어

슬라이딩도어

3연동도어

하키웨이

3연동 V컷팅유리 도어



NEW
대성-353V 씨클
펄백색[5]

• 대성 V컷팅유리 3연동은 글라스에 V형태로 커팅을 한뒤 도어에 설치하여 우아함과 빛나는 아름다움을 연출합니다

NEW



대성-353V 비너스
워시베이지(US201) 54

NEW



대성-353V 포밀러
6405흑단 82

NEW



대성-353V 물방울
스무스오크 53



대성-353V 크로스
워시베이지(US201) 54

인테리어도어

ABS도어

에펠도어

글라스도어

슬라이딩도어

3연동도어

하키웨이

3연동 V컷팅유리 도어



대성-353V 헝클
6405흑단 [82]



대성-353V 키보드
MQ808 [71]



대성-353V 스퀘어
펄백색 [51]



대성-353V 멜로디
6405흑단 [82]

• 대성 V컷팅유리 3연동은 글라스에 V형태로 컷팅을 한뒤 도어에 설치하여 우아함과 빛나는 아름다움을 연출합니다



대성-353V 하모니
브라운월넛 [77]



대성-353V 리듬
FZ805 [74]



대성-353V 옥타브
MQ808 [71]



대성-353V 카오스
FZ805 [74]

인테리어도어

ABS도어

에펠도어

글라스도어

슬라이딩도어

3연동도어

하키웨이

3연동 V컷팅유리 도어



대성-353V 매직
MQ808 



대성-353V 타임
브라운월넛 

• 대성 V컷팅유리 3연동은 글라스에 V형태로 컷팅을 한뒤 도어에 설치하여 우아함과 빛나는 아름다움을 연출합니다

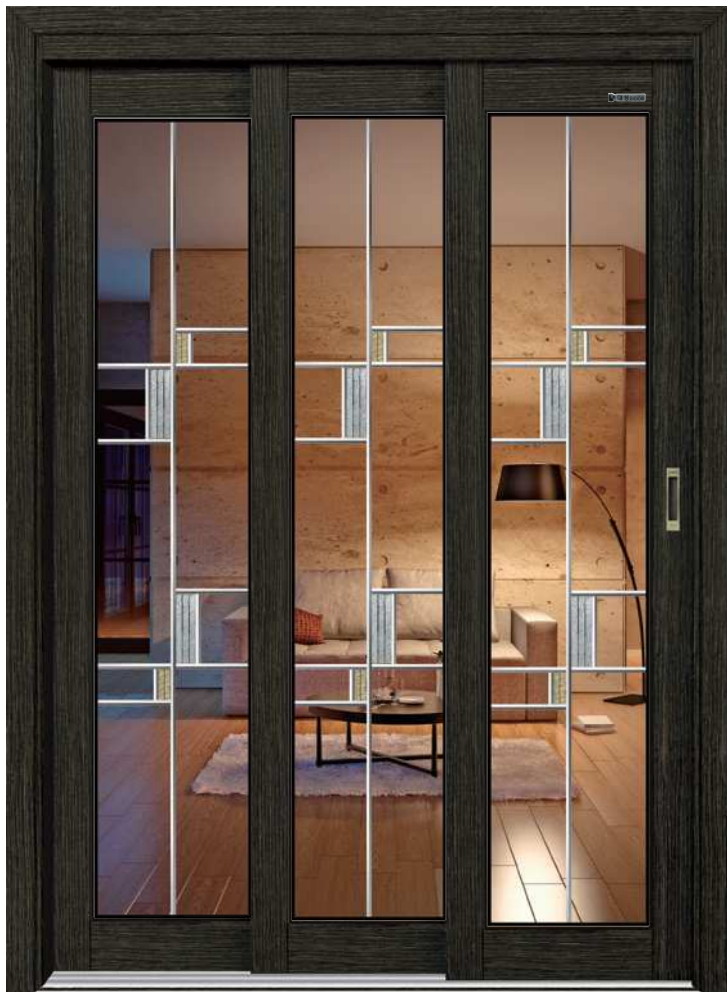

대성-353V 돌체
6405흑단 82



대성-353V 앙상블
크림티크 55

인테리어도어

ABS도어

에펠도어

글라스도어

슬라이딩도어

3연동도어

하늬도어

3연동 베벨드유리 도어



대성-353B 로코코
실버프렌치 57

- 대성의 3연동 베벨드유리 도어는 신주재질을 제품 디자인 형상으로 밴딩 후 정밀세공한 유리를 결합하여 만든 수공예 제품으로 장인정신의 혼이 함께하는 제품입니다

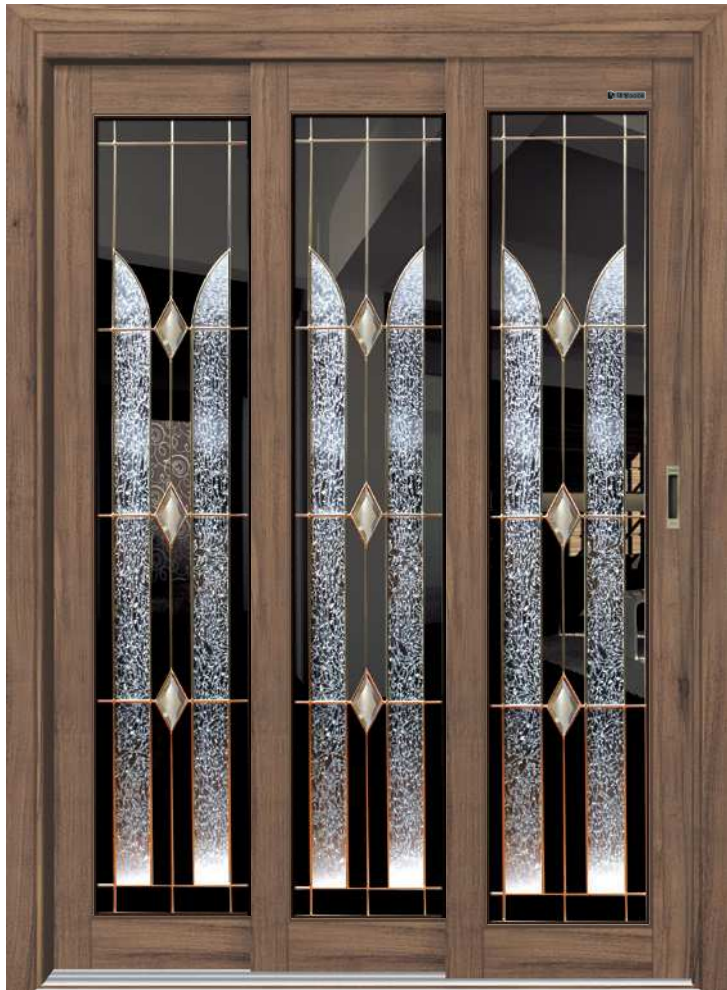

대성-353B 세인트
브라운월넛 77



대성-353B 실크로드
브룩시더 56

3연동 7자중문



대상-파티션D
워시베이지(US201)54+단조패턴705
W : Free적용(고시:에펠도어 몰딩 적용)

• 3연동 ㄱ자 중문은 현관과 실내를 효과적으로 분리 가능하며 단열·방음에도 효과적입니다



대성-파티션F
아카시아 ㄱ + UV유리 예시카
W : 1200~2100 적용(고시:대성 522 콤스타 적용)



대성-파티션E
MQ808 ㄱ + 투명망입
W : 1200이하 적용(고시:대성 518 큐브 적용)

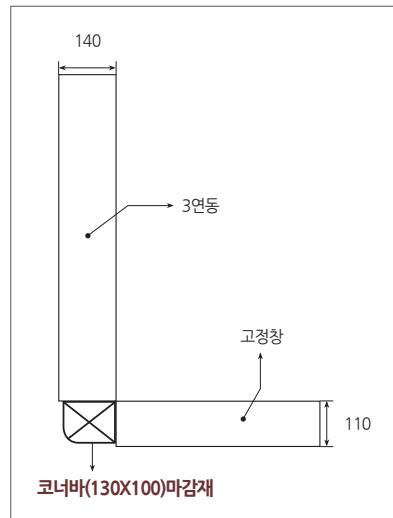

3연동 ㄱ자 중문 단면도

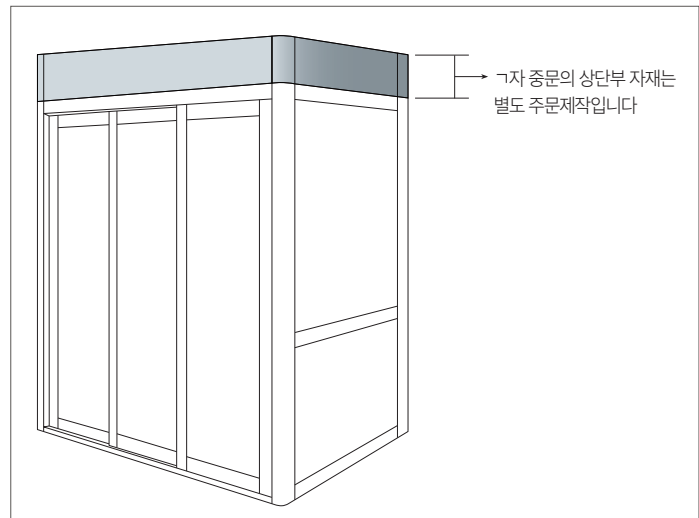

3연동 ㄱ자 중문 상부는 시공 시 설치

2연동 포켓 도어

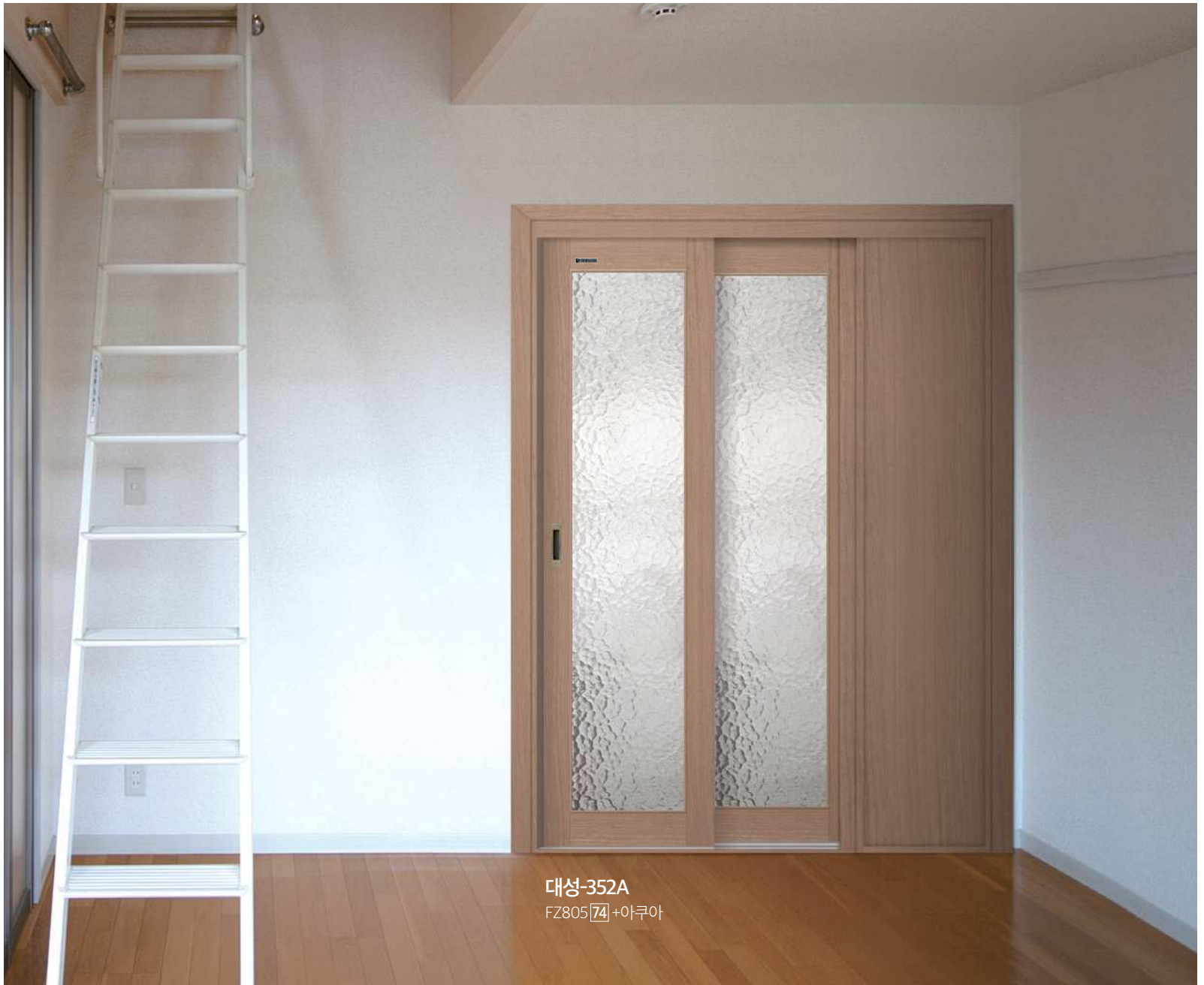

대성-352A
FZ805 74 +아쿠아

연동도어가 포켓속으로 들어가는 깔끔고 안전한
연동 포켓 도어

좌측개구설치(반대방향)

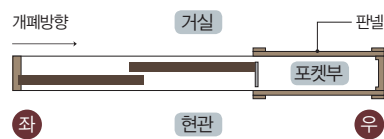

우측개구설치(정방향)

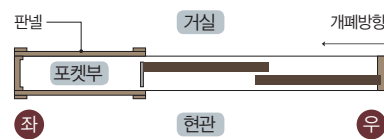

도어(측면)



엣지폴+메탈오목이



하드웨어 & 시스템

행거 도어

- 소음 및 충격이 없습니다.
- 아이들의 안전사고가 일어나지 않습니다.
- 닫힘이 부드럽습니다.
- 댐퍼형 시공 시 오토클로징으로 도어가 닫힐때 소음이 적고, 손끼임방지 기능이 있는 하드웨어입니다.

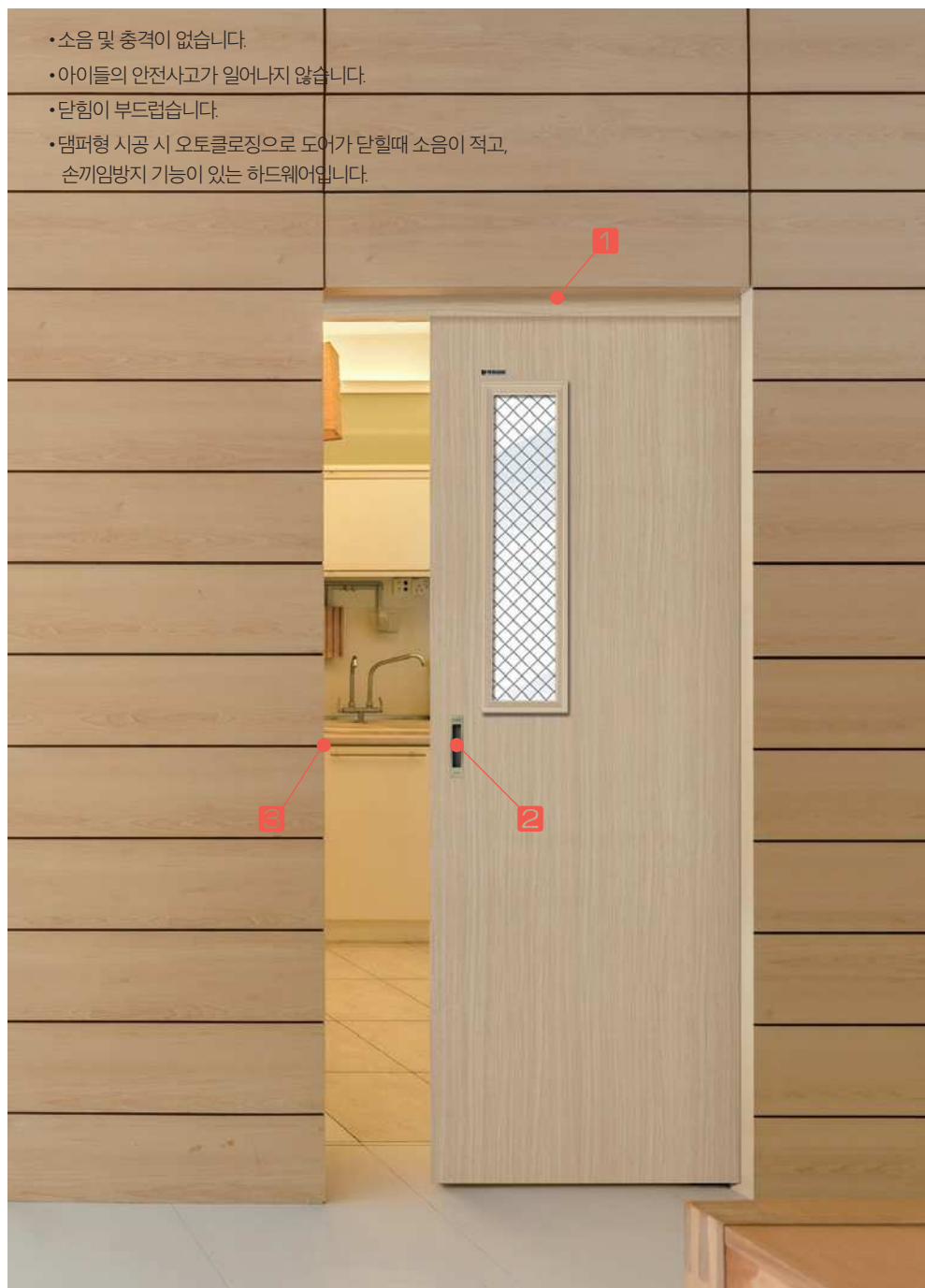

포켓적용으로 공간 활용이 효율적인 세이프티 포켓형 행거 도어

일반행거 상부레일



1 일반행거 철물

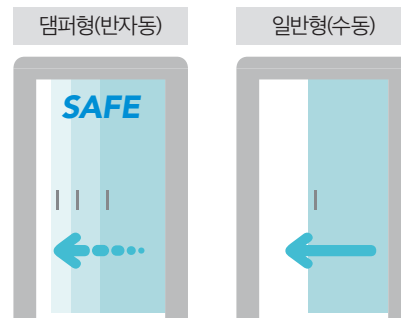
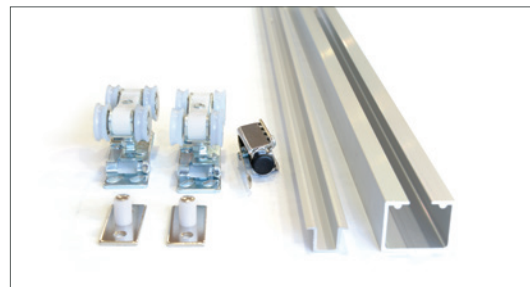

대성-278(행거용)
실버프렌치[57]+망입

댐퍼형(세이프티형)

세이프티행거 상부



1 댐퍼형(한방향)

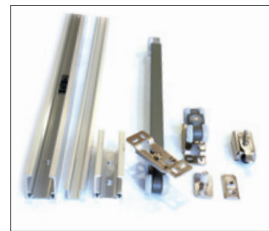

1 댐퍼형(양방향)

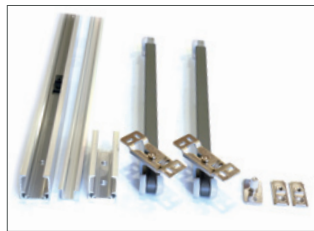

선택사항

2 엣지풀+메탈오목이



2 미서기 잠금장치(버튼형)



3 문틀 잠금장치



※ 시공시 부착

간편한 시공으로 만족감이 높은 노출형 행거 도어

벽면에 바로 시공할 수 있는 장점으로 문틀 설치가 어려운 곳에 적합하며
상업용·주거용 등 다양하게 활용이 가능합니다.

상부롤러



상부 스톱퍼

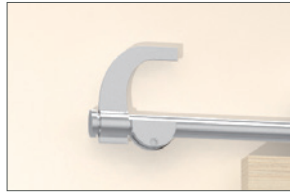

하부 부속



메탈오목이



대성-511 가로결무늬 민판(행거용)
브룩시더(가로) [56-1]

상부롤러



상부 스톱퍼



하부 부속



메탈오목이



대성-511 가로결무늬 민판(행거용)
크림티크(가로) [55-1]

하드웨어 & 시스템

접이행거 도어(폴딩 타입)



대성-609(행거용)
MQ808 [기]+아쿠아

넓은공간의 분리가 쉽고, 개폐가 간편한 접이행거 도어

- 마운트에 고정된 도어는 회전운동만하는 문입니다.
- 접이식 폴딩도어는 짝수로만 제작을 권장합니다.
- 도어폭은 600mm 이하로 주문하여 주십시오.

폴딩 타입

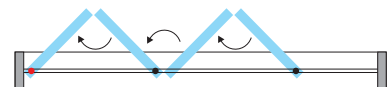

마운트(상부)

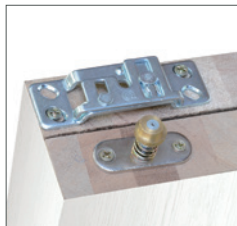
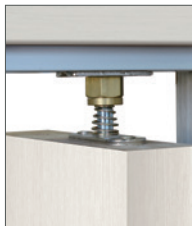

마운트(하부)



접이행거 도어(슬라이딩 타입)



대성- 518(행거용)

워시베이지(US201) 54 +포인트X

- 도어를 접고 펼침에 따라 두 개의 공간을 독립적 또는 일체형으로 활용할 수 있도록 제작된 칸막이 전용 도어입니다.
- 슬라이딩타입은 문짝 중앙에 롤러를 부착하여 2~3짝씩 연결하여 사용하는 방식으로 무게중심이 중앙에 있어 사용중 불량이 없으며 유지 및 관리가 쉽습니다.

슬라이딩 타입

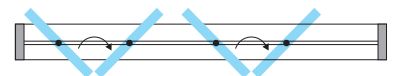

상부롤러



홀딩경첩



하드웨어 & 시스템

미서기



대성-345V 포밀러
크림티크 55

- 부드럽게 열고 닫히도록 설계
- 간편한 시공 및 저렴한 가격
- 뛰어난 내구성(습기에 의한 부식 및 변형, 뒤틀림 없음)
- 다양하고 디테일한 무늬와 UV, 단조, 보석, 아트유리, 커팅, 안전필름접합유리, 망입유리 등 선택의 다양성

실용적이고 내구성이 강해 경제적인 미서기 도어

1 미서기 레일방식

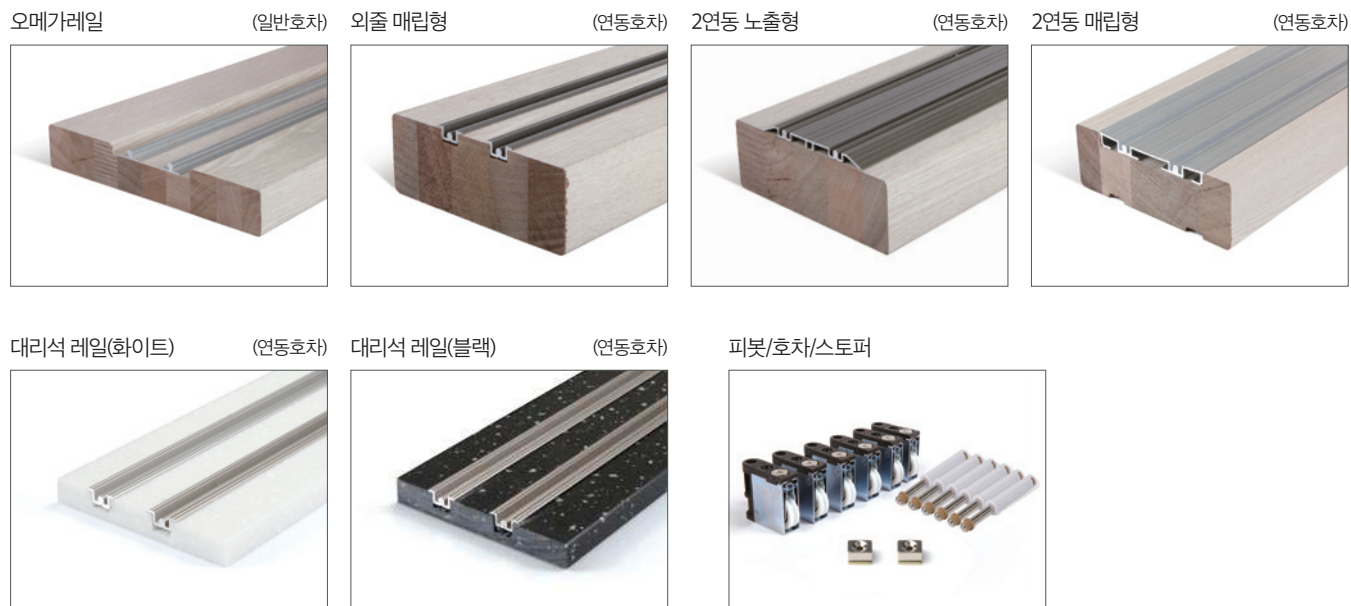

반자동 미서기



대성-345C 발렌타인
펄백색[5]

2 문틀 내부 마감재

미서기 상부 문틀



3 미서기 손잡이

메탈오목이(실버)



메탈오목이(골드)



민다대(홍가공)



4 도어크로저(반자동 노출형)

닫힘



열림



미서기 하부 상세



미서기 상부와 문틀 결합



하드웨어 & 시스템

외짝미서기(노출형 반자동)



대성-305M (반자동)
워시베이지(US201) 54 +망입

간단한 설치로 더욱 편리하게 반자동 외짝미서기 도어

도어크로저 2개를 좌우 대칭으로 부착하면 2짝용 반자동 미서기가 됩니다.
기존 2짝 미서기 제품에도 간단한 부착으로 반자동으로 변경이 가능합니다.

도어크로저(반자동 노출형)

닫힘



열림



목재 외미서기 문틀 / 레일

상부문틀



하부문틀(오메가레일)



외줄 노출형



외짝미서기(일반형)



→ 열림(수동)
← 닫힘(수동)

대성-306A (수동)
스무스오크 53 +아쿠아

외출미서기 문틀(일반형)



대성-520C 아멜리아
워시베이지(US201) 54

1 외출미서기 문틀 (목재, ABS)

53mm(목재)



70mm(목재)



55mm(ABS)



2 미서기 잠금장치

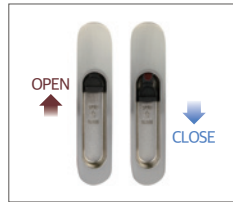

3 문틀 잠금장치



※ 시공시 부착

4 외출미서기 문틀 (행거형)

70mm(하부없음)



110mm(하부없음)



5 하단 부분



외출미서기 문틀(행거형)

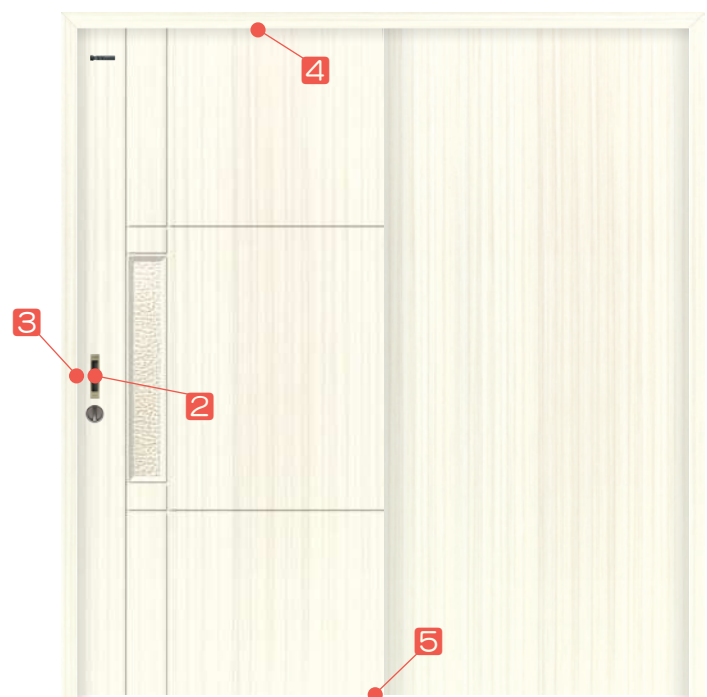

대성-120 모던 (외출미서기)
크림펄 52

하드웨어 & 시스템

3연동 도어



NEW
대성-353C 포피
아카시아 73

부드럽게 닫히는 오일쇼바 구조로 연동문의 품격이 올라갑니다

- 좁은 공간 활용 극대화
- 부드러운 연동 시스템(엘리베이터 작동 원리)
- 작동 거리만큼 움직이는 안전성
- 시공 및 문 장착의 편리성
- 일본 및 한국 특허제품
- 간편한 시공(철물이 문틀에 시공되어 출고되므로 문틀을 세우고, 문짝을 끼우기만 하면 됨)



댐퍼 미사용
무거운 문이 문틀과 충돌하면
집이 "깡" 울립니다.



댐퍼 사용
무거운 문이 문틀과 충돌하기전 오일
쇼바가 먼저 충격을 흡수합니다.

- 댐퍼는 정상방향(우→좌)으로 1개 적용됩니다. (추가설치는 옵션사항)

1 상부철물

댐퍼 3연동 상부 철물

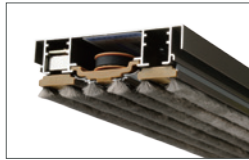

연동 댐퍼

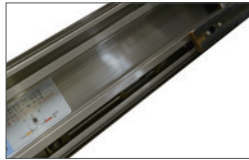

3연동 고정용 스토퍼



2 미서기 손잡이

메탈오목이(실버)



메탈오목이(골드)



민다대(홍가공)



3 하부레일

알루미늄 레일

오메가레일(실버, 카키)

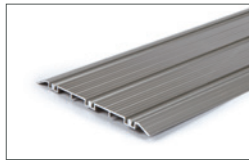

V레일(실버, 먹회색)



외줄 매립형



3연동 매립형(실버, 먹회색)

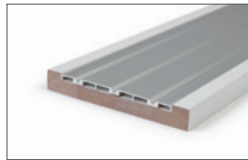

대리석 레일

대리석 레일(화이트)



대리석 레일(블랙)

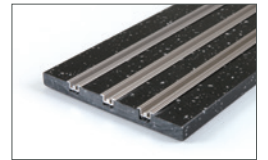

4 3연동 문틀

3연동 목재 알루미늄 결합 문틀(외풍차단)

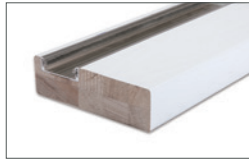

ABS문틀(외풍차단 불가)



5 3연동 중앙문

외풍차단 기능



깔끔하고 부드럽게 닫히는 자석 스토퍼



강력자석(히토류) 금속재

깨짐·마모 등 변형이 없는 구조



마모 깨짐 관리가 어려운 기존 스토퍼 변형이 없는 구조

※ 문무게에 맞추어 (소,중,대) 자석을 사용하면 들림, 튀김이 발생하지 않습니다.



※ 드라이버로 풀고 이동하여 조절합니다.

연동식 도어 시공 순서 및 방법

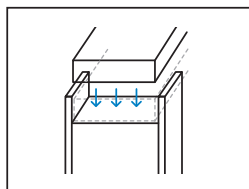

1 좌우 문틀을 상·하부 홈 가공 부위에 고정시킴

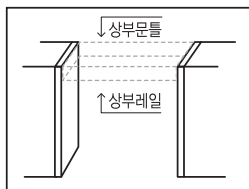

2 조립된 문틀을 벽체에 고정시킴

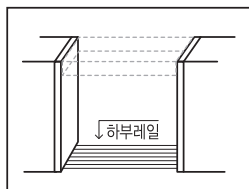

3 고정된 문틀하부에 하부레일을 실리콘으로 고정시킴 (3면 문틀일 때 적용, 수평을 정확히 시공 할것)

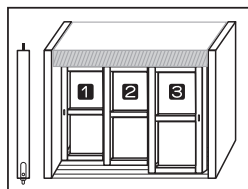

4 문짝은 1-2-3 순서로 조립함. 하부로라를 조정하여 수평을 잡음 (2번 중앙문은 외풍차단형 확인함)

하드웨어 & 시스템

3연동 도어 미서기 잠금장치



연동도어도 잠금장치로 안전하게! 연동 도어 잠금장치

1 미서기 잠금장치(버튼형)

열림 상태



닫힘 상태



전면



2 1번도어 고정 스톱퍼



소프트 댐퍼 3연동 도어



대성-소프트 댐퍼 3연동 (1/2고시)
브룩시더56+투명망입

부드러운 닫힘으로 더욱 조용하게, 안전하게 소프트 댐퍼 3연동 도어

속도조절이 가능한 소프트 댐퍼 3연동 도어는 문이 닫히기 20cm 전부터
부드럽게 속도가 줄어듭니다

인테리어 도어

ABS 도어

에펠도어

클라시도어

슬라이딩도어

3연동도어

하키웨이

하드웨어 & 시스템

양개도어 하드웨어



대성-267F (양개)
실버프렌치 57
단조패턴666+마스터라인(세로)

1 여닫이 바람막이(마감재)

양개도어에 설치하는 바람막이 몰딩으로 틈새로 들어오는 바람 및 소음 등을 차단합니다. 사후 부착 시공방식으로 시공이 간편하면서 마감이 깔끔합니다.

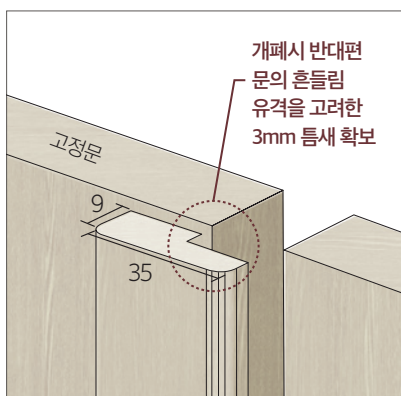

2 매입오도시

양개도어 상·하부에 매립형으로 설치되는 잠금장치입니다.



열림



잠금

윈드컷

소음 차단 및 방풍 효과를 한번에!
윈드컷

도어하단에 매립하여 문을 닫았을 때 문틈을 막아주어
소음 및 공기를 차단해주는 시스템입니다.



인테리어도어

ABS도어

에펠도어

글라스도어

슬라이딩도어

3면도어

하늬도어

하드웨어 & 시스템

도어락

모티스락

5010 GR

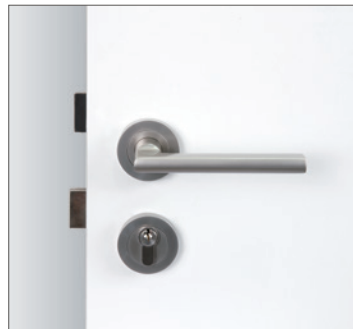

3110 GR

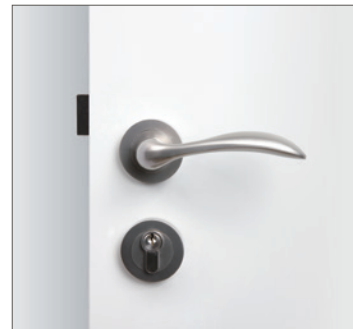

도어락 일반형



36 DW



35 DW



281 DB



801 PC 화이트



501 GR



311 GR



911 PC(블랙)



114 GR



101 DS

경첩

이지경첩



블랙



화이트



실버



골드

나비경첩



실버

스토퍼(일자형)



일반형 (90mm)



일반형 (120mm)

현관 보조 잠금장치

전면



잠금



열림



미서기 잠금장치

분리형(36mm)

골드, 실버 (키 x)



일체형(36mm)

골드, 실버 (키 O)



버튼형(32, 36mm겸용)

골드, 실버 (키 x)



미서기 핸들

엣지풀



메탈오목이(실버)



메탈오목이(골드)



메탈오목이(검정)



기본형(실버)



매립형(여닫이용)



안전 도어락

개폐모드



안전모드



도어핸들 회전부
- 개폐모드, 안전모드 설정

완충부
- 문틀과 도어핸들의 충격흡수패드

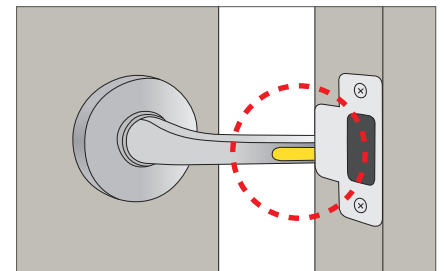

525 Green



525 Yellow



525 Gray

하드웨어 & 시스템

평판몰딩(전체 컬러 운영)

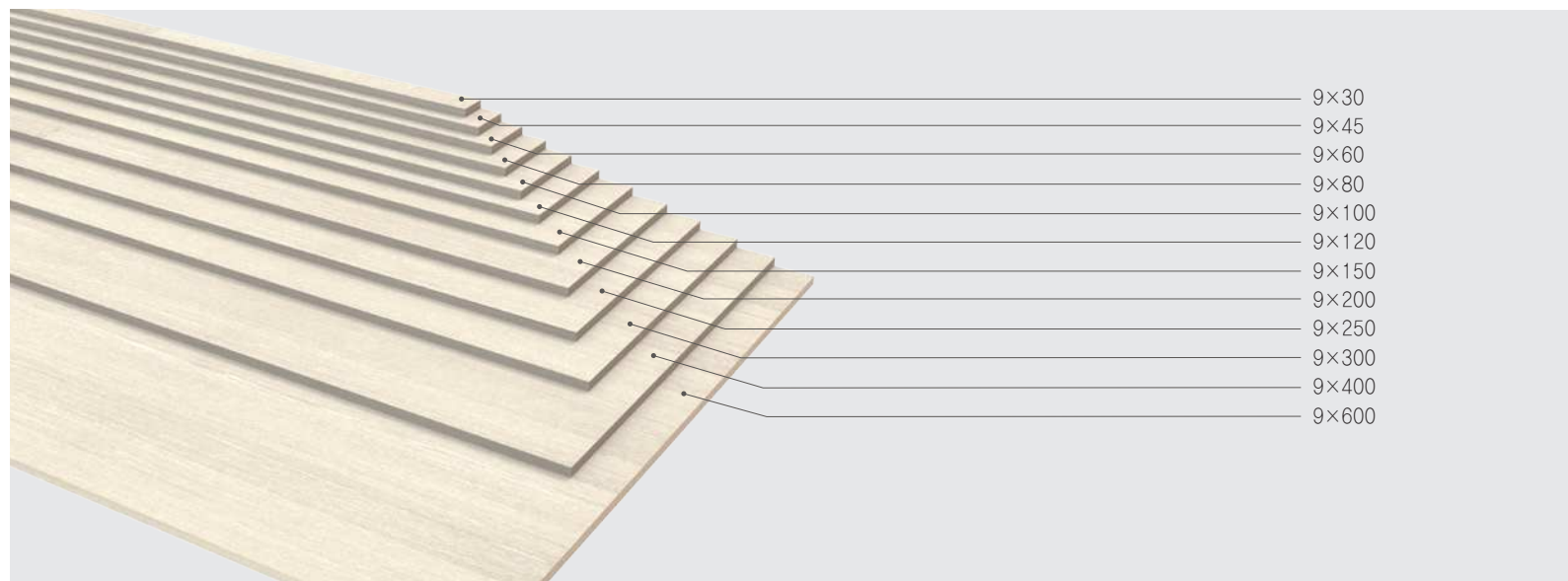

천정 몰딩

60 × 12



70 × 12



80 × 12



90 × 12



110 × 15



각구문선

45 × 18



반달문선

60 × 15



왕관문선

60 × 15

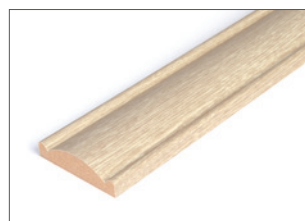

평문선

60 × 12



라인문선

60 × 12



계단 몰딩

2계단 50 × 12



3계단(소) 50 × 15

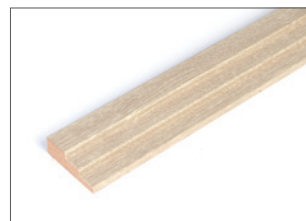

3계단(대) 68 × 15



4계단 68 × 18



코너 기차

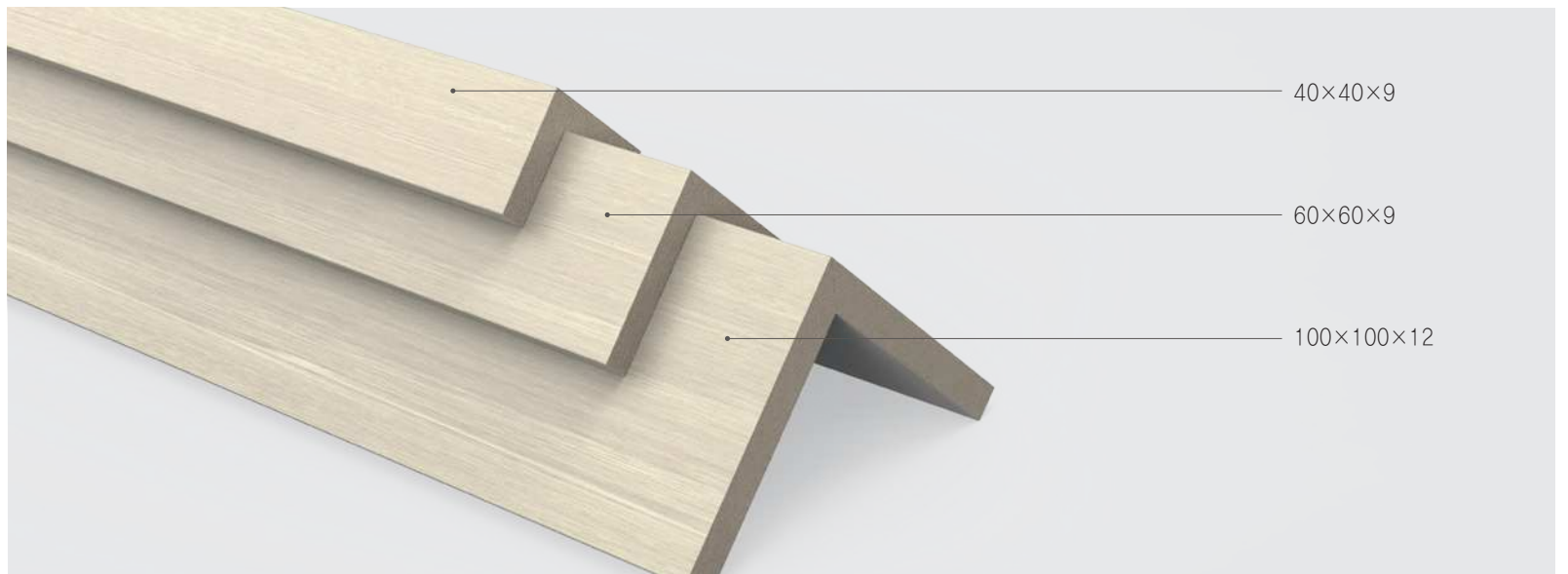

루바

헤드셋



학교용 걸레받이

일반 걸레받이

강화 걸레받이

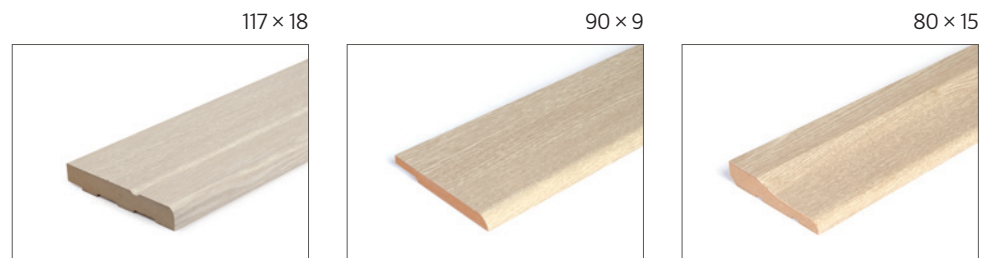

마이너스 몰딩

재료분리대

루바 마감재

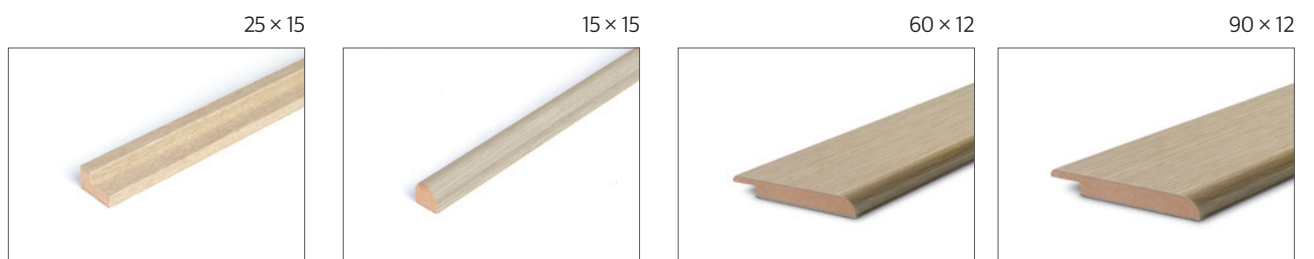

하드웨어 & 시스템

목재 도어 프레임

일체형

110mm(외도어)



140mm(양도어)



170mm(양도어)



200mm(양도어)



230mm(양도어)



분리형 문틀 (와이드형)

110mm / 140mm / 170mm / 200mm / 230mm



- ① 문틀과 스토퍼가 분리되어 시공이 편리합니다.
- ② 와이드 스토퍼를 적용하여 문틀이 깔끔하고 공간이 넓어 보이는 효과가 있습니다.

스토퍼용 가스켓 색상



가틀캡형 문틀 (가변형)

일면 문선형 (가틀캡 50×30, 50×20)



양면 문선형 (가틀캡 50×20)



문선 없는 형 (가틀캡 50×30)

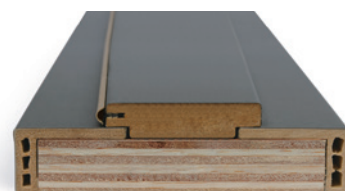

주문방법

- 발주시 문틀캡이 포함된 사이즈로 주문해주시요.
- 문선의 유무를 구분해서 주문해주시요. (일반, 양면, 문선없음)

- LVL 가틀 선 시공 후 PVC 캡과 스토퍼를 시공하는 방식으로 시공 중 오염이나 파손문제를 해결
- 후 시공 방식으로 보양작업이 필요없음
- 내구성과 습기에 강함
- 가스켓 스토퍼 적용으로 밀폐력 및 방음효과의 성능 향상

ABS 도어 프레임

일반형

110mm



130mm



140mm



155mm

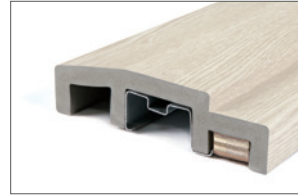

175mm

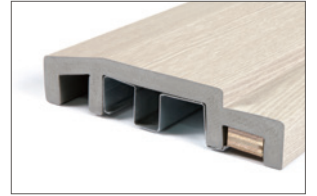

195mm

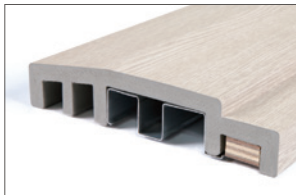

210mm



230mm

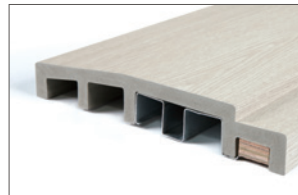

245mm



가스켓형

110mm



130mm



140mm



155mm



175mm



195mm



210mm



230mm



245mm



판넬 문틀

50T (외경 92mm)



75T (외경 110mm)



100T (외경 140mm)



인테리어도어

ABS도어

에펠도어

글라스도어

슬라이딩도어

3계열도어

하니웨어

하드웨어 & 시스템

미서기 문틀

목재 미서기 문틀

110mm



140mm



170mm



200mm



230mm



ABS 미서기 문틀

110mm



140mm



목재 외미서기 문틀

53mm



70mm



ABS 외미서기 문틀

55mm



래핑 미서기 행거용 문틀

70mm 외줄용



110mm 외줄용



110mm 2줄용



70mm(하부없음)



110mm(하부없음)



110mm(하부없음)



단조패턴

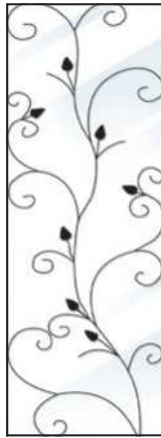

401

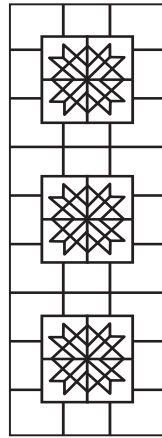

402



403



404

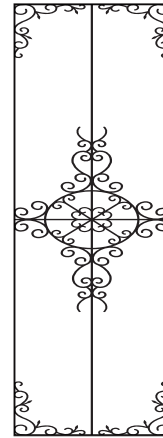

406



407

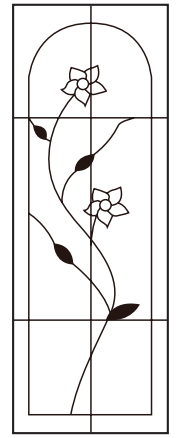

408



409

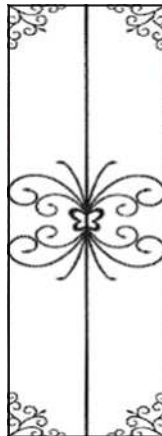

411

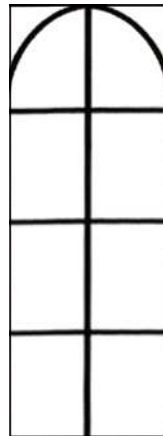

412

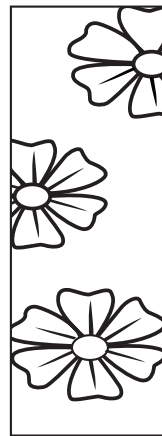

413



414



415

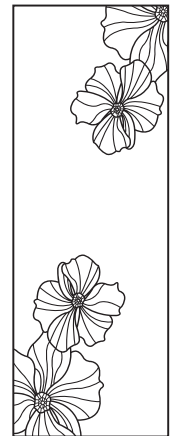

416



417



418



419



420

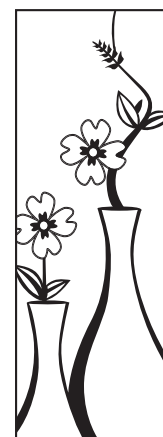

421



422

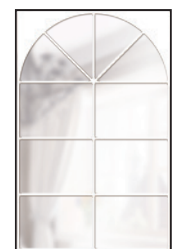

423

인테리어도어

ABS도어

에펠도어

플라스틱도어

슬라이딩도어

3계열도어

하니웰도어

하드웨어 & 시스템

단조패턴

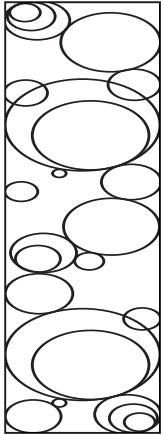

601

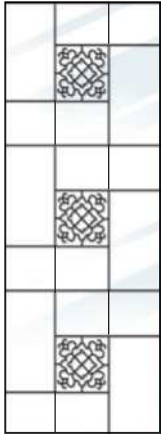

602



603



604

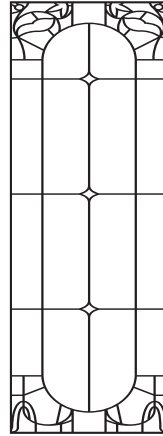

605

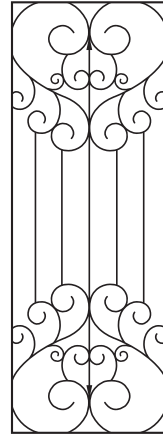

606

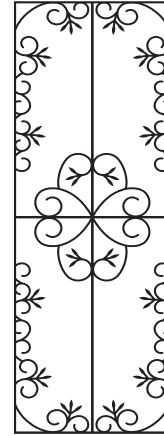

607

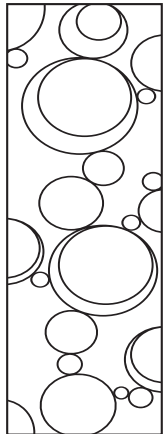

608

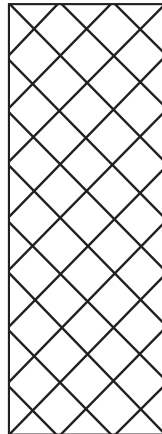

609

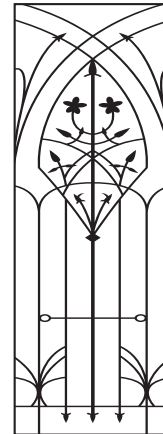

610

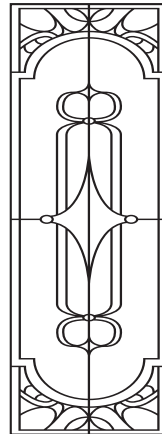

611

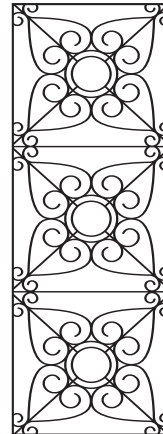

612

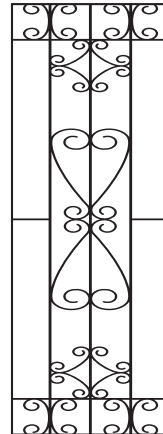

613

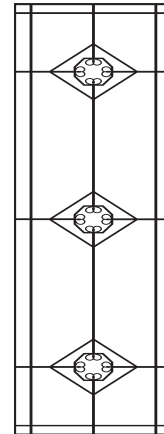

614



615



616



617



618



619

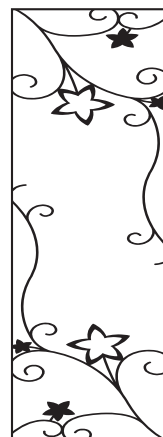

620

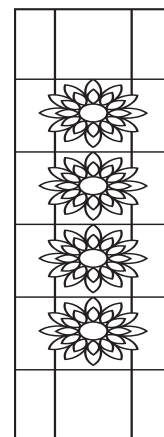

621

단조패턴

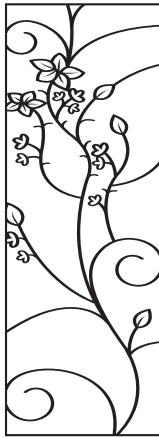

622



623



624

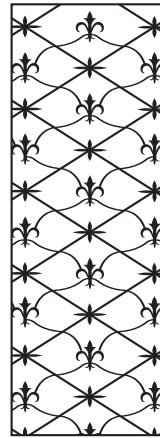

625

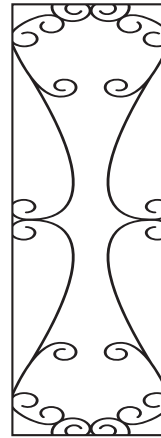

626

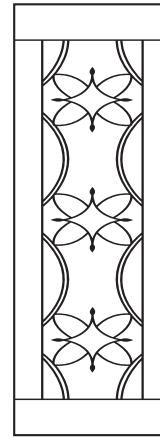

627

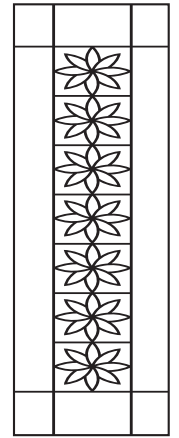

628

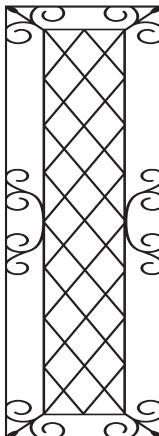

629

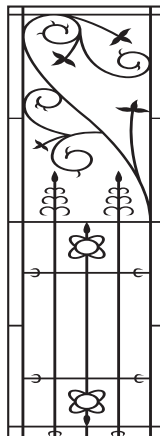

630

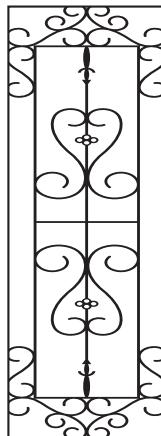

631

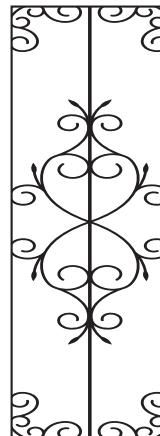

632

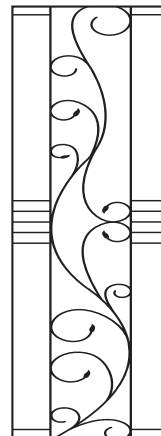

633

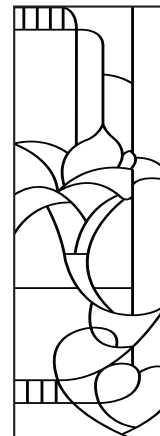

634

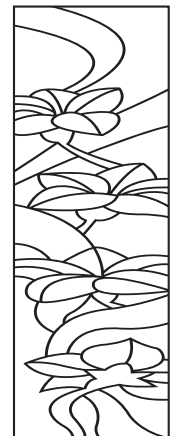

635

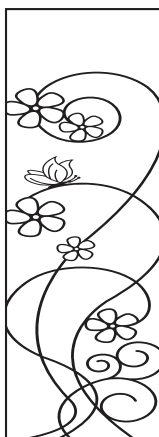

636



637

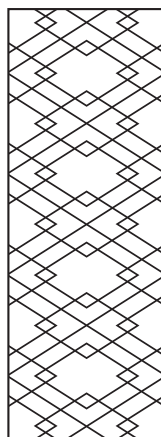

638

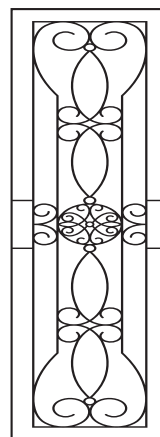

639

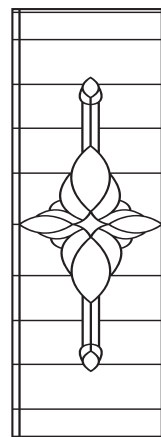

640

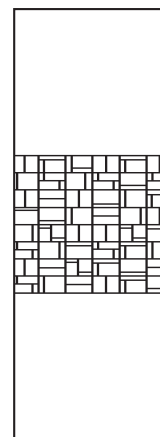

641

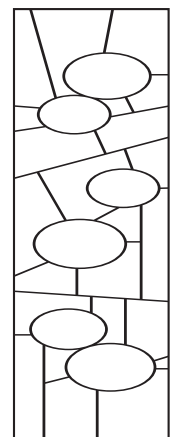

642

하드웨어 & 시스템

단조패턴



643



644



645

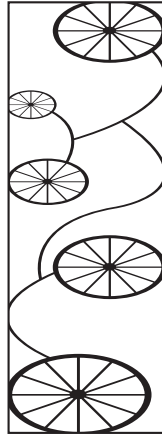

646



647

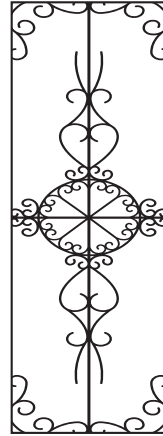

648



649

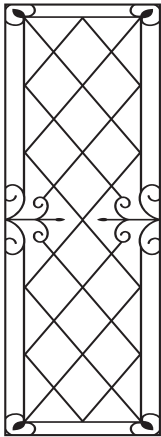

650



730



731

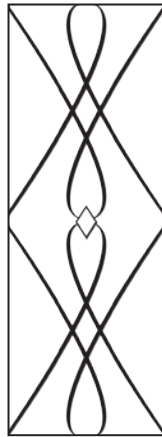

732

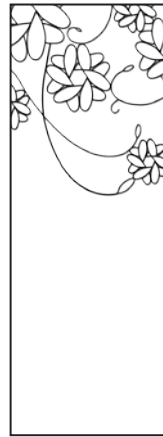

733



734

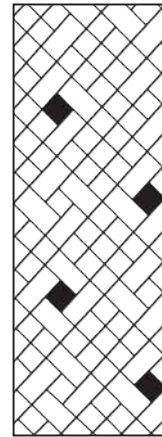

735



736

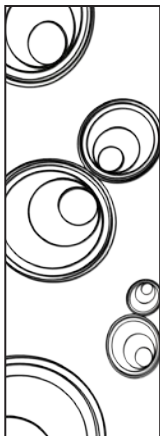

737

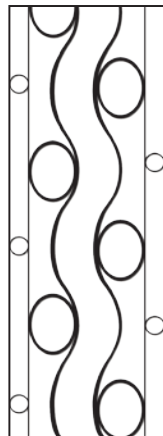

738

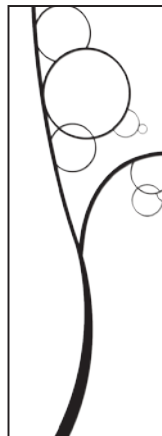

739

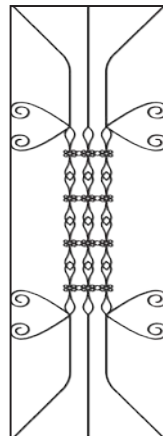

740

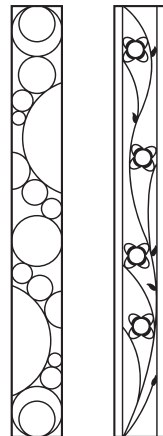

651

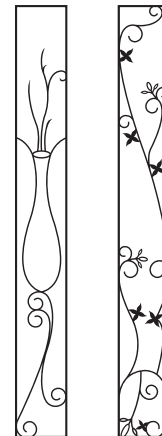

652

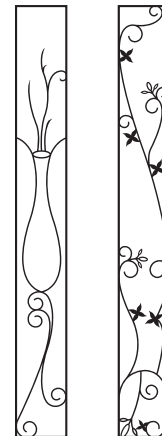

653

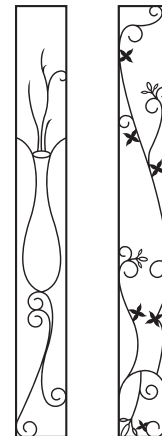

654

단조패턴

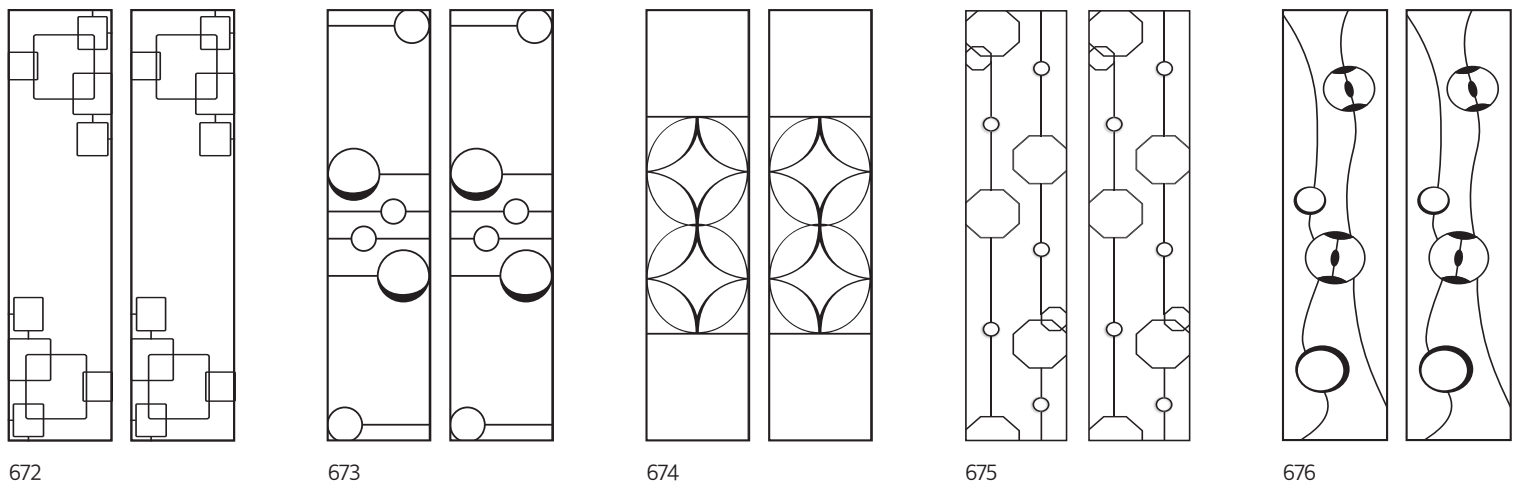
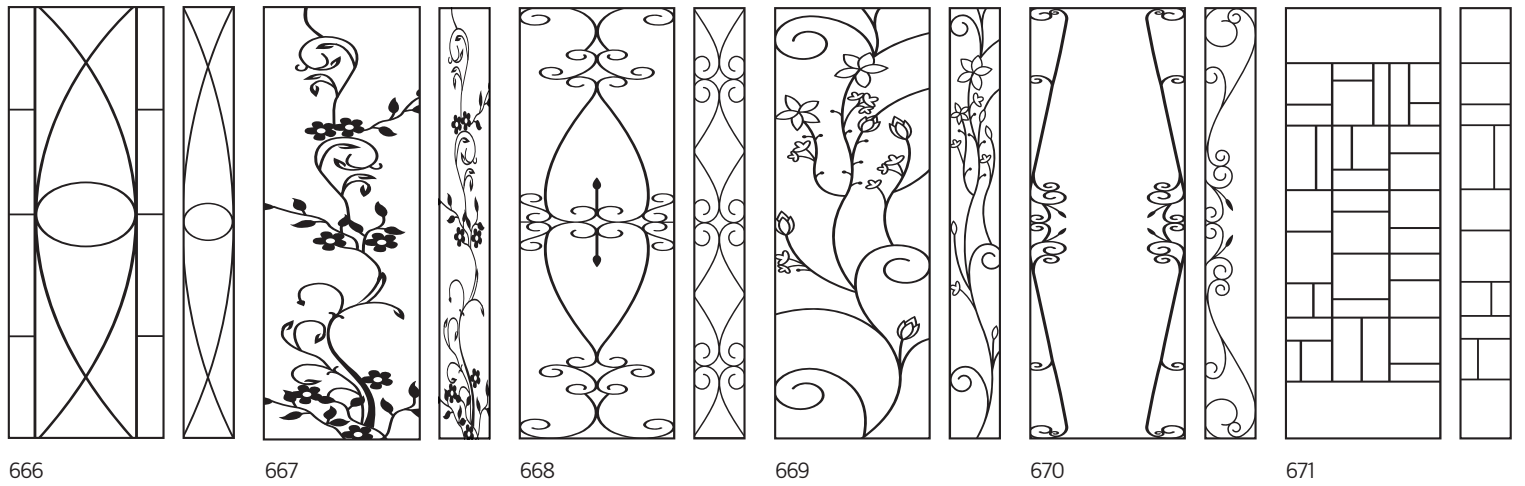
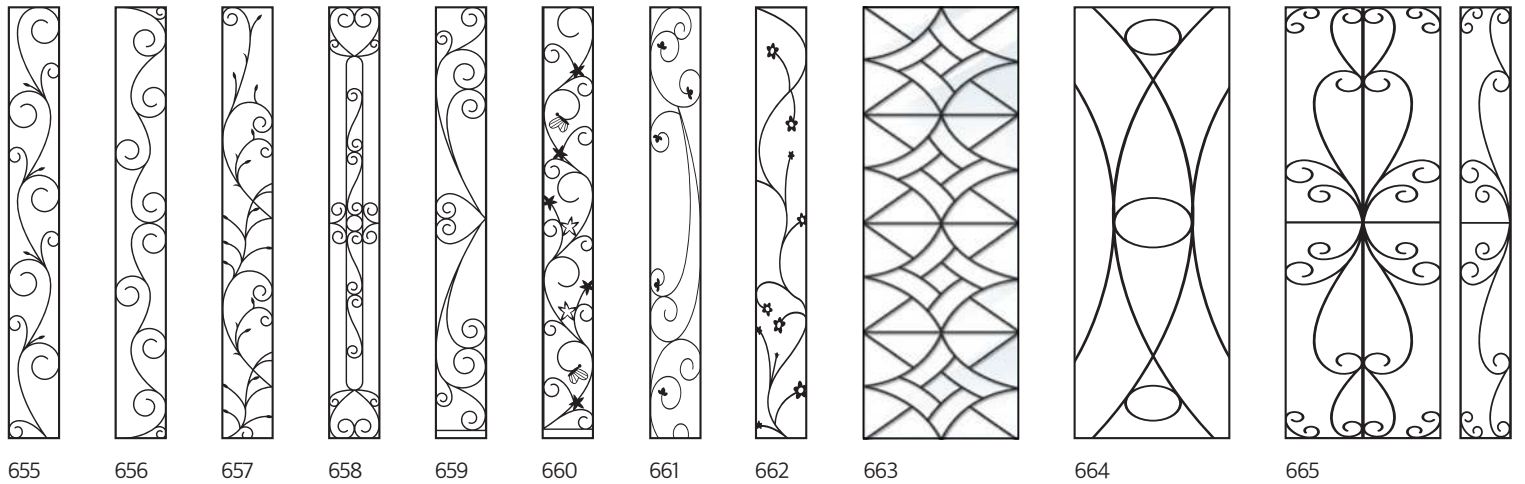

인테리어도어

ABS도어

에펠도어

플라스틱도어

슬라이딩도어

3계열도어

하키도어

하드웨어 & 시스템

단조패턴



742

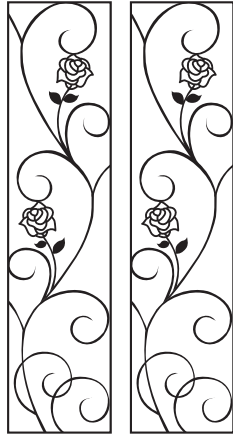

743

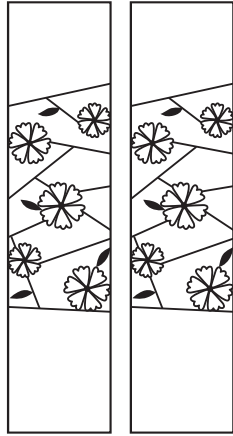

744



745



746



747



748

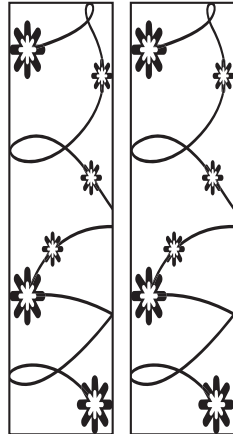

749

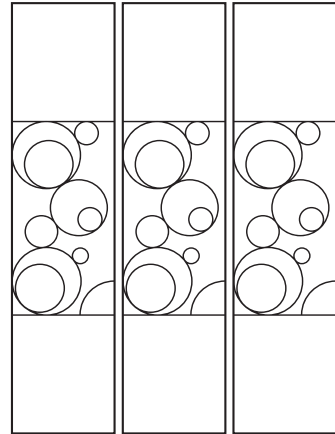

677

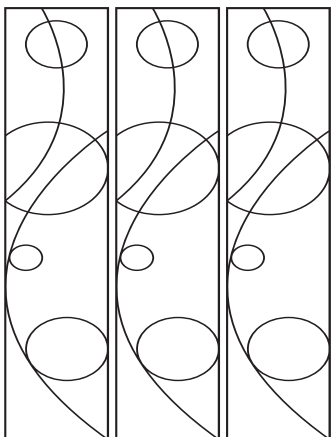

678

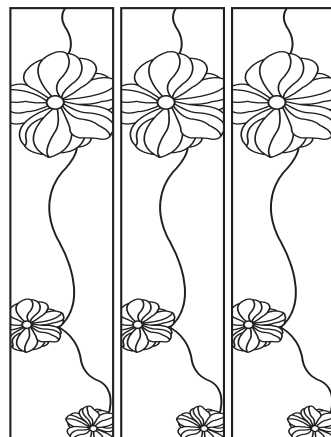

679

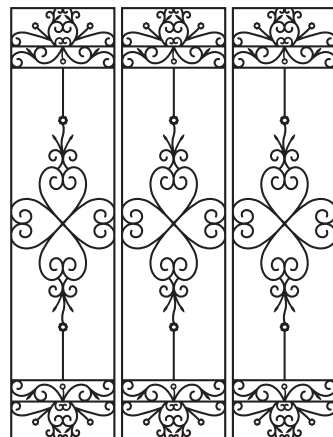

680



681

단조패턴



682



683

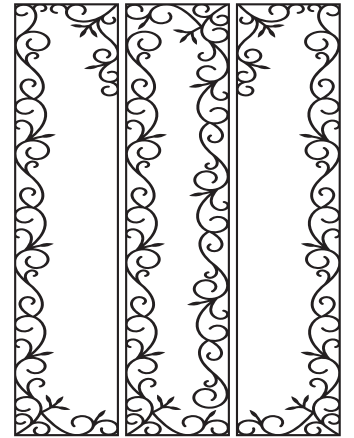

684



685

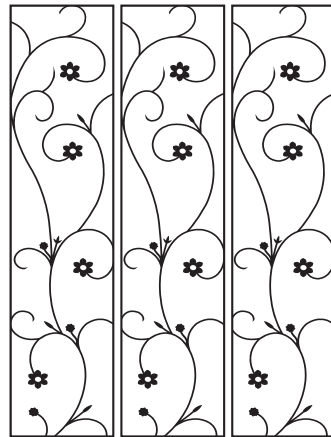

686



687



688

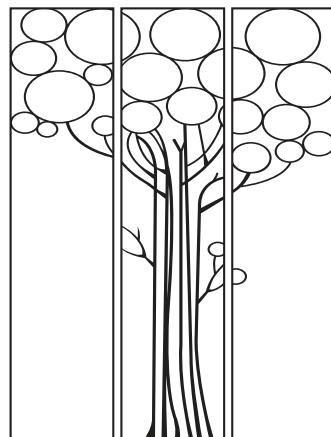

689

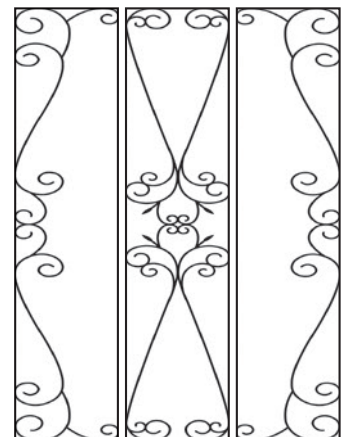

690

인테리어도어

ABS도어

에펠도어

글라스도어

슬라이딩도어

3면도어

하키도어

하드웨어 & 시스템

단조패턴

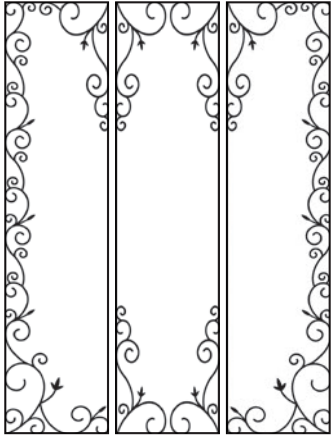

691



692



693

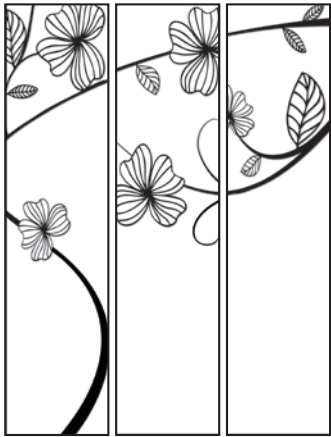

694



695



696

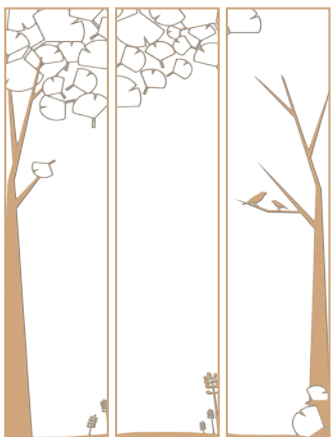

697



698



699

단조패턴



700

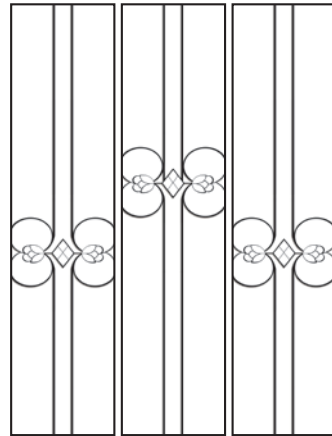

701



702

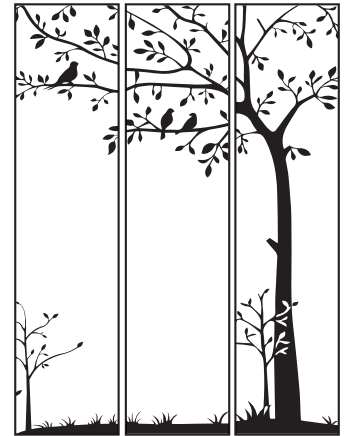

703

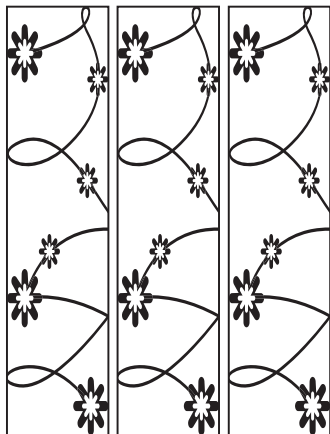

704

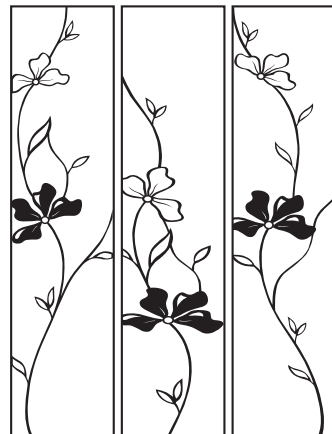

705

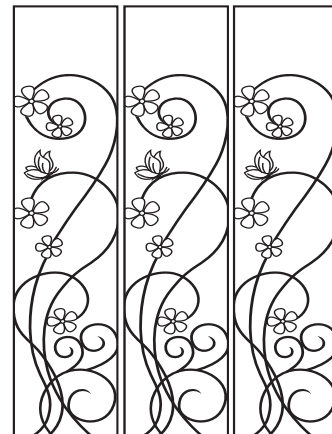

706

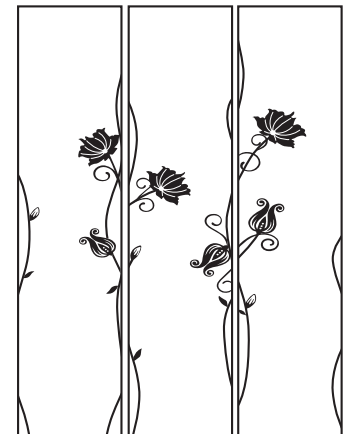

707

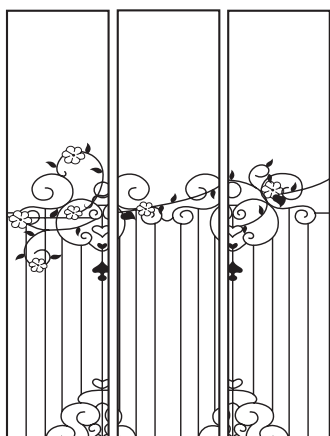

708

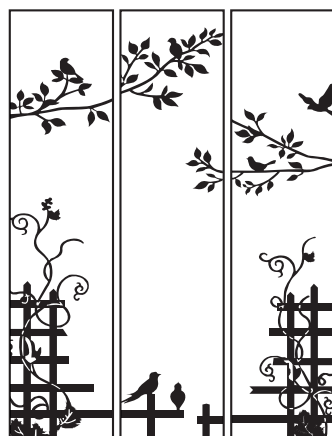

709

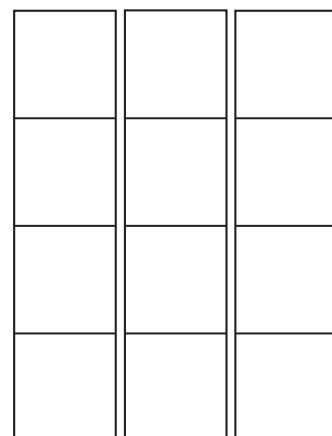

710

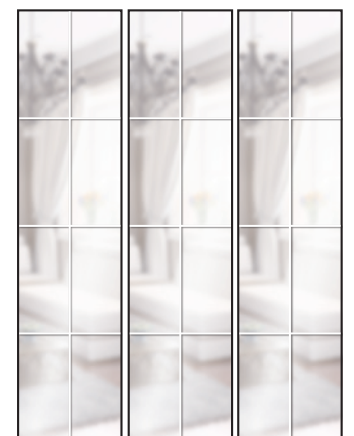

711

인테리어도어

ABS도어

에펠도어

글라스도어

슬라이딩도어

3면도어

하키웨이