

NEW

\*기존제품 일부변경

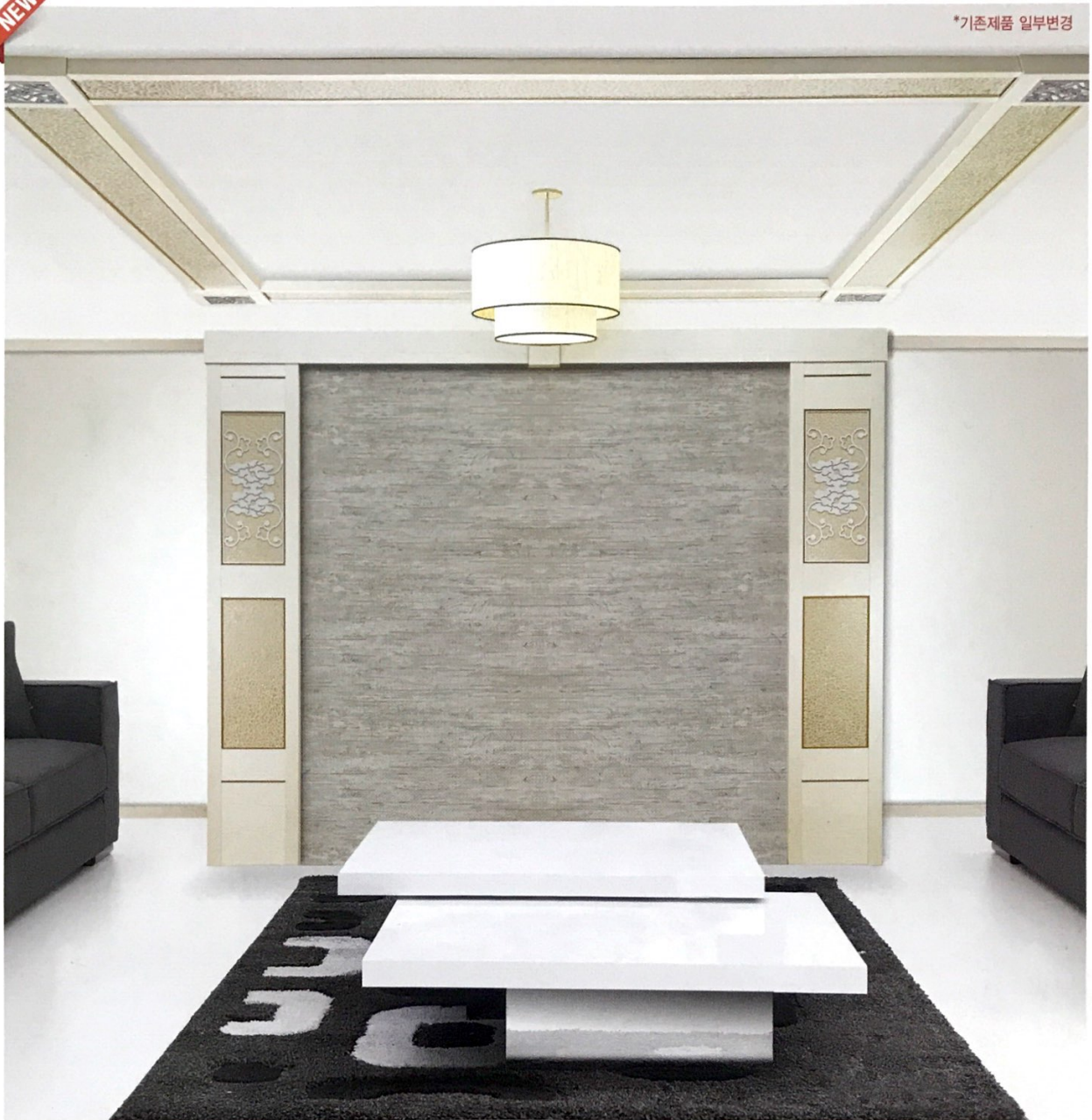

### 아트월 & 등박스 6 [단조] 월판넬 [YST\_030]

#### 아트월 규격

- 기둥 : 2,440 × 450 × 65 × 65
- 보 : 2,440 × 150 × 80
- 이음캡 : 160 × 90
- 1Set 기본단위 : 기둥 2EA / 보 2EA / 이음캡 1EA

#### 등박스 규격

- 몰딩 : 2,440 × 240 × 40 × 40
- 코너프레임 : 250 × 250 × 50
- 코너약세사리 : 180 × 180 × 9
- 1Set 기본단위 : 몰딩 4EA / 코너프레임 4EA / 코너약세사리 4EA

#### 월판넬 규격

- YST\_030 : 600 × 2,400 × 4.5/6T



몰딩 컬러 : 펄백색



단조 컬러 : 실버



단조 컬러 : 화이트



포인트 : 버블

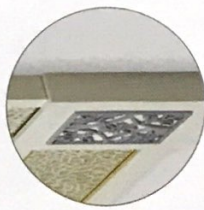

코너프레임 : 실버/화이트



월판넬 : YST\_030

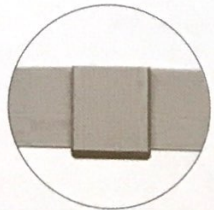

이음캡 상세

HIT



**아트월 & 등박스 9 / 9-1 [자개 / 화이트]  
월판넬 [YST\_010]**

**아트월 규격**

- 기둥 : 2,400 × 400 × 65 × 65
- 보 : 2,400 × 250 × 65 × 65
- 1Set 기본단위 : 기둥 2EA / 보 1EA

**등박스 규격**

- 몰딩 : 2,440 × 240 × 15
- 코너프레임 : 280 × 280 × 25
- 1Set 기본단위 : 몰딩 4EA / 코너프레임 4EA

**월판넬 규격**

- YST\_010 : 600 × 2,400 × 4.5/6T



몰딩컬러 : 그레이오크  
엘리오크



포인트컬러 : 자개

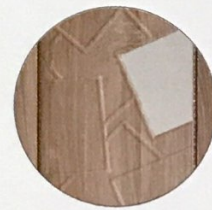

포인트 : 화이트



월판넬 : YST\_010



코너프레임 : 자개

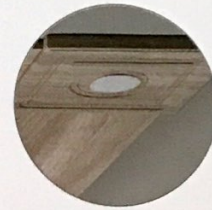

코너프레임 : 화이트

HIT



아트월 & 등박스

ART WALL

30 / 31

**아트월 & 등박스 10 [자개]**  
**월판넬 [엠보 YMD\_010]**

- 아트월 규격**
- 기둥 : 2,400 × 400 × 65 × 65
  - 보 : 2,400 × 250 × 65 × 65
  - 1Set 기본단위 : 기둥 2EA / 보 1EA

- 등박스 규격**
- 몰딩 : 2,440 × 240 × 15
  - 코너프레임 : 280 × 280 × 25
  - 1Set 기본단위 : 몰딩 4EA / 코너프레임 4EA

- 월판넬 규격**
- YMD\_010 : 600 × 2,400 × 4.5/6T

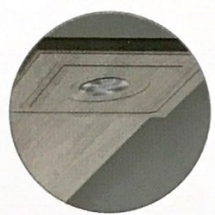

코너프레임 : 자개



몰딩컬러 : 엘리오크

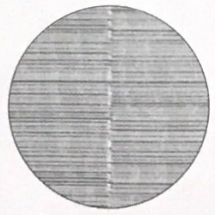

월판넬 : 엠보 YMD\_010  
펄백색

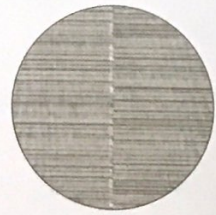

월판넬 : 엠보 YMD\_010  
US201

HIT



아트월 & 등박스 8-1 [서클]  
월판넬 [YST\_020]

아트월 규격

- 기둥 : 2,400 × 400 × 65 × 65
- 보 : 2,400 × 250 × 65 × 65
- 1Set 기본단위 : 기둥 2EA / 보 1EA

등박스 규격

- 몰딩 : 2,440 × 240 × 15
- 코너프레임 : 280 × 280 × 25
- 1Set 기본단위 : 몰딩 4EA / 코너프레임 4EA

월판넬 규격

- YST\_020 : 600 × 2,400 × 4.5/6T



몰딩컬러 : 그레이오크



포인트 : 서클

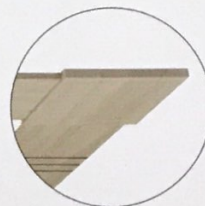

코너프레임



월판넬 : YST\_020

HIT



아트월 & 등박스

ART WALL

32 / 33

### 아트월 & 등박스 8-2 [다이아] 월판넬 [YPU\_020]

#### 아트월 규격

- 기둥 : 2,400 × 400 × 65 × 65
- 보 : 2,400 × 250 × 65 × 65
- 1Set 기본단위 : 기둥 2EA / 보 1EA

#### 등박스 규격

- 몰딩 : 2,440 × 240 × 15
- 코너프레임 : 280 × 280 × 25
- 1Set 기본단위 : 몰딩 4EA / 코너프레임 4EA

#### 월판넬 규격

- YPU\_020 : 600 × 2,400 × 4.5/6T

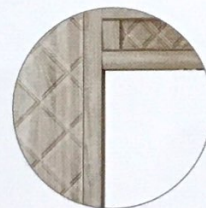

몰딩컬러 : 엘리오크

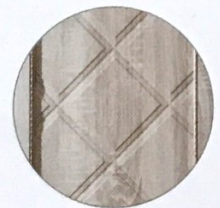

포인트 : 다이아



월판넬 : YPU\_020

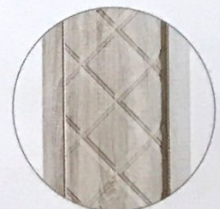

등박스 : 다이아

아트월 & 등박스 8-3  
월판넬 [YPU\_070]

아트월 규격

- 기둥 : 2,400 × 400 × 65 × 65
- 보 : 2,400 × 250 × 65 × 65
- 1Set 기본단위 : 기둥 2EA / 보 1EA

등박스 규격

- 몰딩 : 2,400 × 240 × 15
- 코너프레임 : 280 × 280 × 25
- 1Set 기본단위 : 몰딩 4EA  
코너프레임 4EA



포인트 : 카오스



몰딩컬러 : 그레이오크



등박스 : 카오스



아트월 & 등박스 1

아트월 규격(기본 간접 제품)

- 기둥 : 2,400 × 400 × 93 × 53
- 보 : 2,400 × 250 × 93 × 53
- 1Set 기본단위 : 기둥 2EA / 보 1EA

등박스 규격

- 몰딩 : 2,400 × 240 × 15
- 코너프레임 : 280 × 280 × 25
- 1Set 기본단위 : 몰딩 4EA  
코너프레임 4EA

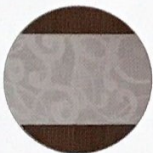

포인트 : 실내라이트



몰딩컬러 : FW503



등박스 : 실내라이트



NEW



\* 기존제품 일부변경

### 주방 아트월 1 월판넬 [YPU\_060]

#### 아트월 규격

- 기둥 : 2,440 × 200 × 40 × 40
- 상부기둥 : 1,200 × 200 × 40 × 40
- 코너프레임 : 210 × 210 × 70

#### 월판넬 규격

- YPU\_060 : 600 × 2,400 × 4.5/6T



몰딩컬러 : 에다지26



월판넬 : YPU\_060



코너프레임



### 주방 아트월 2 월판넬 [YST\_010]

#### 아트월 규격

- 기둥 : 2,440 × 200 × 40 × 40
- 상부기둥 : 1,200 × 200 × 40 × 40
- 코너프레임 : 210 × 210 × 70

#### 월판넬 규격

- YST\_010 : 600 × 2,400 × 4.5/6T



몰딩컬러 : 엘리오크



월판넬 : YST\_010



코너프레임

## 대리석, 인조가죽, 패브릭 등 다양한 소재로 공간에 표정을 부여하다!

예다지의 월판넬은 시공이 간편하고,  
각 소재에 따라 고유의 텍스처를 느끼실 수 있습니다.  
다양한 월판넬의 믹스매치를 통해 원하는 분위기로  
자유롭게 연출해보세요.

### 월판넬 대리석

\*대리석 / 콘크리트 포인트시트 사용

**NEW** YST\_040  
600 × 2,400 × 4.5 / 6

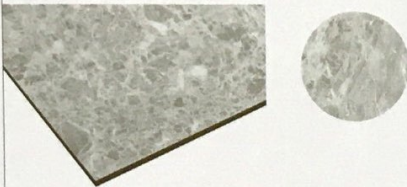

**NEW** YST\_050  
600 × 2,400 × 4.5 / 6



**HIT** YST\_010  
600 × 2,400 × 4.5 / 6



**HIT** YST\_020  
600 × 2,400 × 4.5 / 6



**HIT** YST\_030  
600 × 2,400 × 4.5 / 6



### 월판넬 엠보

\*전 엠보판넬 컬러 변경 가능

YMD\_010 [필백색]  
600 × 2,400 × 4.5 / 6

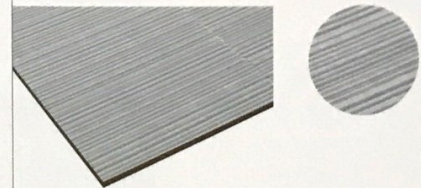

YMD\_010 [US201]  
600 × 2,400 × 4.5 / 6



YMD\_020 [FW503]  
600 × 2,400 × 4.5 / 6



YMD\_020 [US201]  
600 × 2,400 × 4.5 / 6

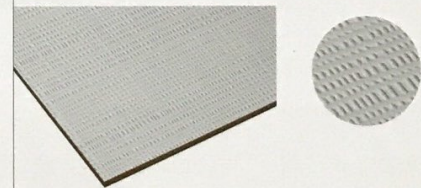

YMD\_030 [FW503]  
600 × 2,400 × 4.5 / 6

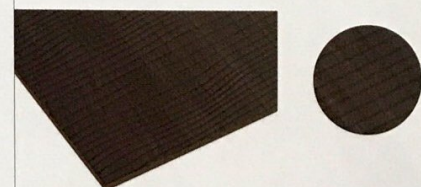

YMD\_030 [예다지28]  
600 × 2,400 × 4.5 / 6

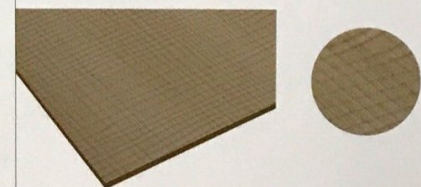

YMD\_030 [필백색]  
600 × 2,400 × 4.5 / 6

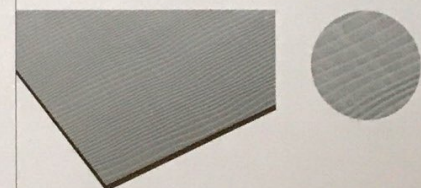

월판넬 인조가죽

YPU\_010  
 600 × 2,400 × 4.5 / 6



YPU\_020  
 600 × 2,400 × 4.5 / 6



YPU\_050  
 600 × 2,400 × 4.5 / 6



YPU\_060  
 600 × 2,400 × 4.5 / 6

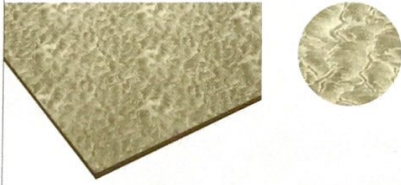

YPU\_070  
 600 × 2,400 × 4.5 / 6

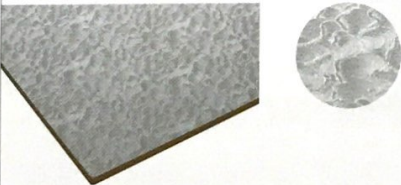

YPU\_080  
 600 × 2,400 × 4.5 / 6

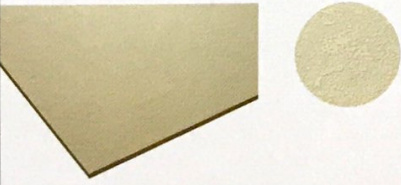

YPU\_090  
 600 × 2,400 × 4.5 / 6



월판넬 패브릭

YFB\_010  
 600 × 2,400 × 4.5 / 6



YFB\_030  
 600 × 2,400 × 4.5 / 6



YFB\_040  
 600 × 2,400 × 4.5 / 6



월판넬 마감 몰딩

확장 몰딩  
 40 × 2,440 × 9

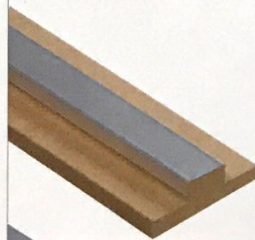

마감 몰딩  
 25 × 2,440 × 9

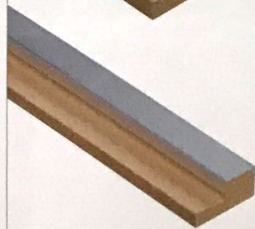

내열, 내수성이 탁월한 PVC소재의 렉스판은  
 습기, 오염에 강해 건축 내외장재로 널리 사용됩니다!

렉스판

\*소재 : 8자, 10자, 12자

백색목  
 300 × 2,400 × 10



백색  
 300 × 2,400 × 10

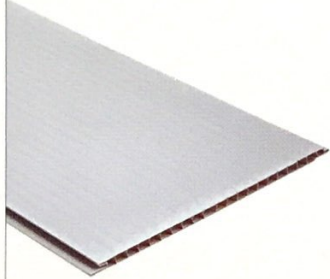

자개  
 300 × 2,400 × 10

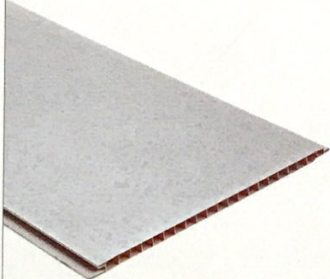

줄무늬  
 300 × 2,400 × 10

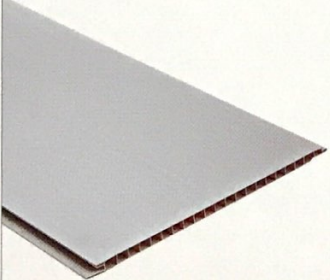

다이아  
 300 × 2,400 × 10

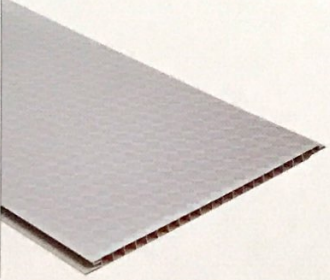

PVC 몰딩

\*단수 판매만 가능

3계단  
 45 × 15 × 2,400



2계단 중  
 40 × 15 × 2,400



2계단 소  
 30 × 12 × 2,400



문선  
 45 × 15 × 2,400



504 몰딩  
 35 × 20 × 2,400



505 몰딩  
 45 × 20 × 2,400



H-이음  
 10 × 10 × 2,400

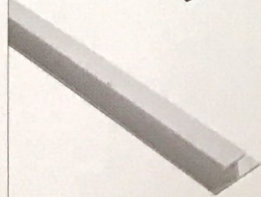



NID130  
[프렌치오크] - 리얼 스틸



NID130  
[U6405] - 덩쿨



NID130  
[필백색] - 덩쿨



리얼 스틸

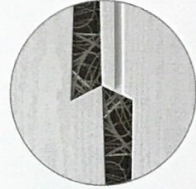

덩쿨

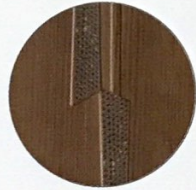

삼각 크리스탈



NID140  
[에다지34] - 안개 라인



NID140  
[FW503] - 헤어 라인 블랙



NID140  
[에다지31] - 라인 크리스탈



안개 라인



라인 크리스탈



헤어 라인 블랙

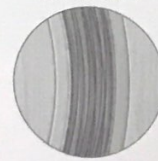

헤어 라인 실버



NID150  
 [예다지38] - 나뭇잎\_퍼플



NID150  
 [UH401] - 나뭇잎\_그린



NID160  
 [필백색] - 하트\_실버



전구\_크리스탈



전구\_블랙(야광)



전구\_화이트(야광)



NID160  
 [프렌치오크] - 하트\_블랙

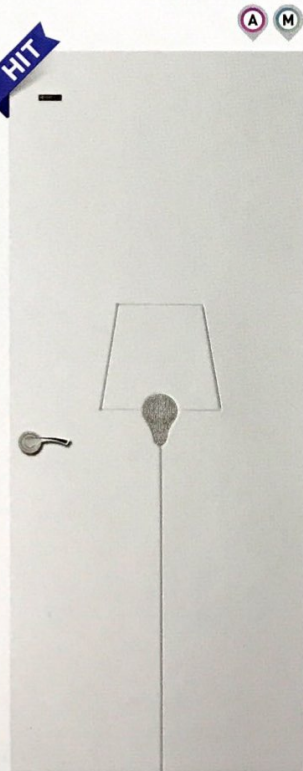

NID170  
 [WAL94] - 전구\_크리스탈



NID170  
 [예다지104] - 전구\_블랙(야광)

A M

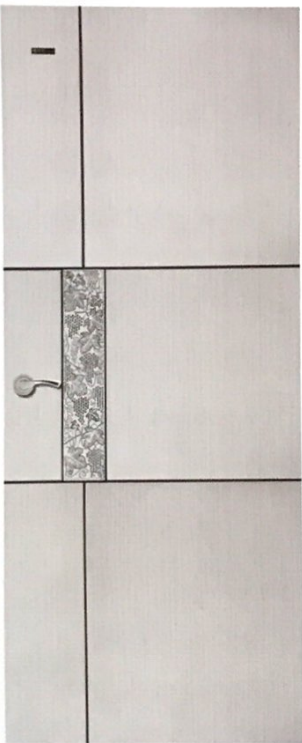

NID100  
[에다지38] - 포도

A M



NID100  
[FZ805] - 해당화

A M



NID120  
[FW503] - 화이트필

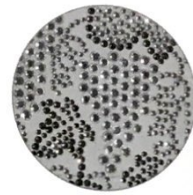

포도

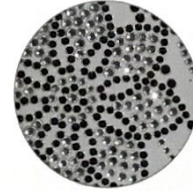

해당화



화이트필

A M



NID120  
[US201] - 블랙필

A M



NID120  
[WAL94] - 자개

A M

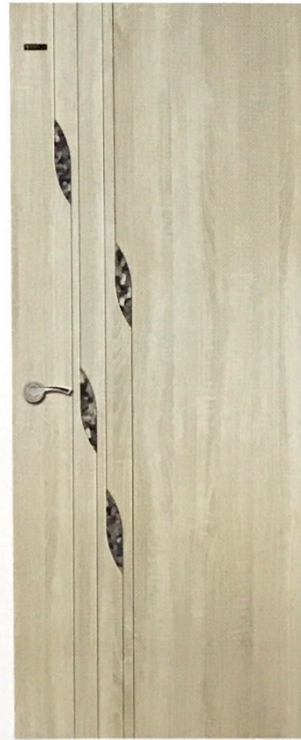

NID120  
[그레이오크] - 자개



블랙필



자개

나뭇잎을 모티브로 블랙필, 자개 소재를 이용한 매력적인 그라데이션 패턴이 돋보입니다.



지브라



나이테



문살



NID110  
 [US201] - 지브라



NID110  
 [엘리오크] - 나이테



NID110  
 [아카시아] - 문살



필백색



블랙(U6405)



엘레강스(블랙)



NID110  
 [U6405] - 필백색



NID110  
 [엘리오크] - 블랙(U6405)



NID110  
 [그레이오크] - 엘레강스(블랙)



NID110  
[US201] - 실버로즈



NID110  
[UH401] - 골드로즈



NID110  
[아카시아] - 엘레강스 (화이트)



실버로즈



골드로즈



엘레강스 (화이트)



NID100  
[FW503] - 민들레 (옐로우)



NID100  
[US201] - 민들레 (블랙)



NID100  
[그레이오크] - 민들레 (화이트)

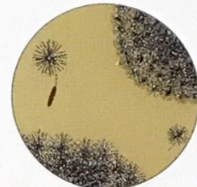

민들레 (옐로우)

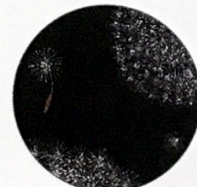

민들레 (블랙)



민들레 (화이트)



블랙



블루스타



아네모네

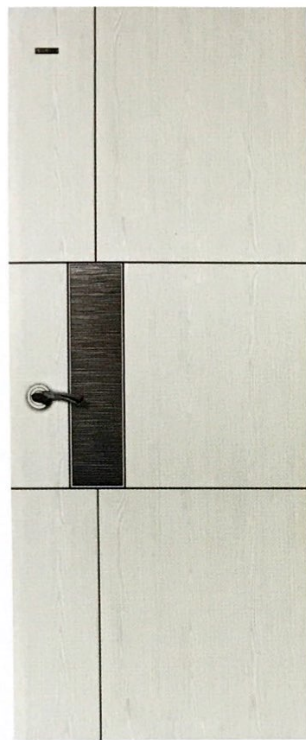

NID100  
 [US201] - 블랙

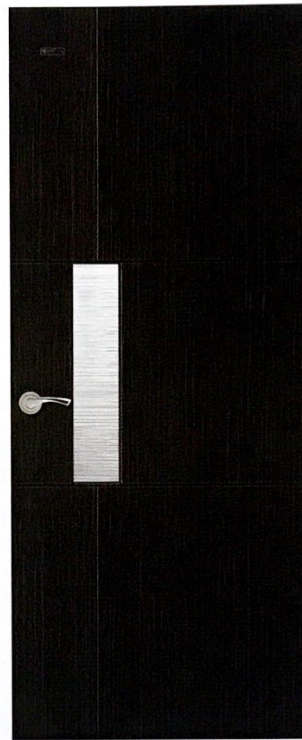

NID100  
 [U6405] - 필백색



NID100  
 [UH401] - 블루스타



NID100  
 [UH401] - 실버로즈



NID100  
 [엘리오크] - 골드روز



NID100  
 [FW503] - 아네모네



NID100  
 [US201] - 람베이지



NID100  
[UH401] - 유니크

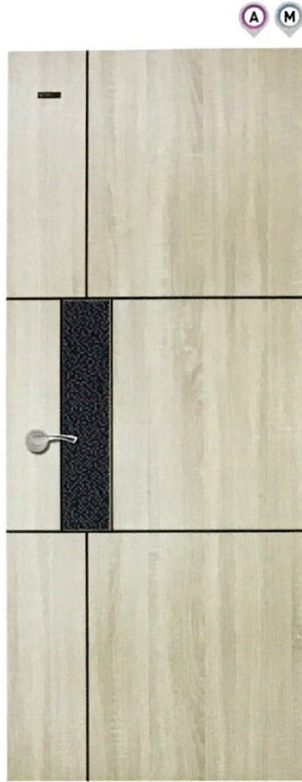

NID100  
[그레이오크] - 모자이크

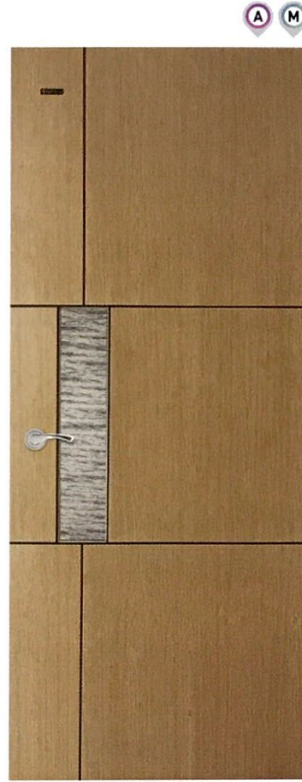

NID100  
[M3701] - 제브러



유니크



모자이크

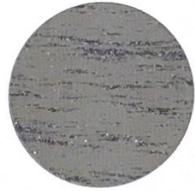

제브러



NID010  
[MW602] - 나비넝쿨(블랙)



NID010  
[U6405] - 나비넝쿨(옐로우)



NID010  
[US201] - 베이지



NID010  
[필백색] - 월넛

대한민국 특허청  
 디자인 등록

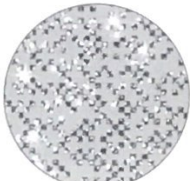

은하수



웨이브

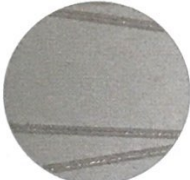

실버라인

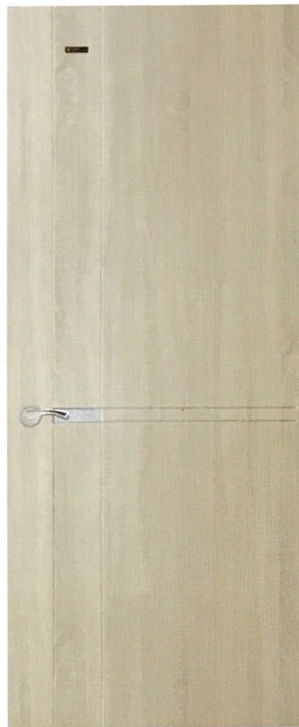

NID020  
 [그레이오크] - 은하수

대한민국 특허청  
 디자인 등록

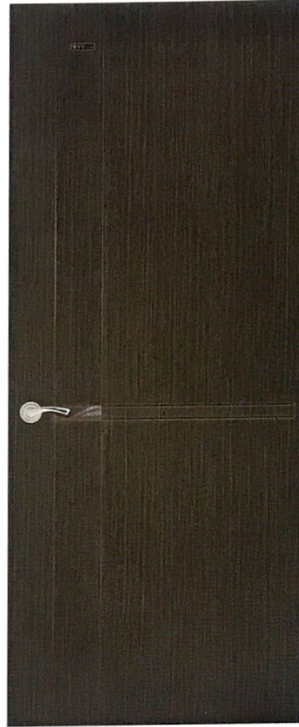

NID020  
 [U6405] - 웨이브

대한민국 특허청  
 디자인 등록



NID020  
 [US201] - 실버라인

대한민국 특허청  
 디자인 등록



월넛



카키



별꽃



NID030  
 [FW503] - 월넛

대한민국 특허청  
 디자인 등록



NID030  
 [프렌치오크] - 카키

대한민국 특허청  
 디자인 등록



NID050  
 [UH401] - 별꽃

대한민국 특허청  
디자인 등록

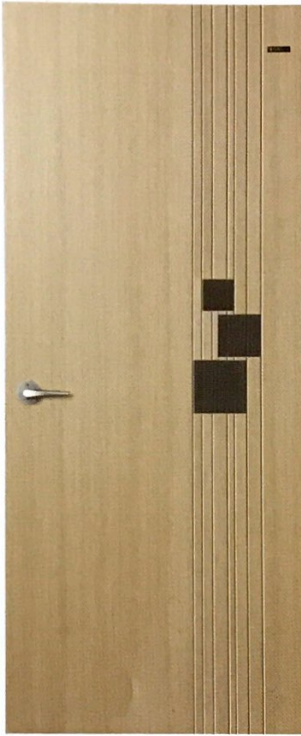

NID050  
[MW602] - MO503

대한민국 특허청  
디자인 등록



NID050  
[UH401] - 민들레 (옐로우)

대한민국 특허청  
디자인 등록



NID050  
[U6405] - 민들레 (화이트)

대한민국 특허청  
디자인 등록



NID050  
[그레이오크] - 민들레 (블랙)

대한민국 특허청  
디자인 등록



NID050  
[엘리오크] - MO501

대한민국 특허청  
디자인 등록



NID050  
[FZ805] - MO502

대한민국 특허청  
디자인 등록



NID050  
[그레이오크] - 해당화



MO501



MO502

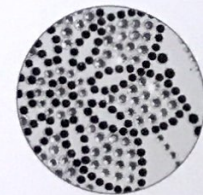

해당화

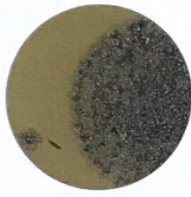

만들레 (옐로우)



만들레 (화이트)



만들레 (블랙)

대한민국 특허청  
 디자인 등록



NID060  
 [MW602] - 만들레 (옐로우)

대한민국 특허청  
 디자인 등록

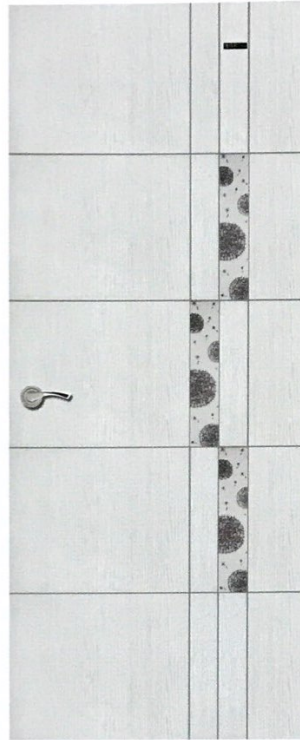

NID060  
 [FW602] - 만들레 (화이트)

대한민국 특허청  
 디자인 등록

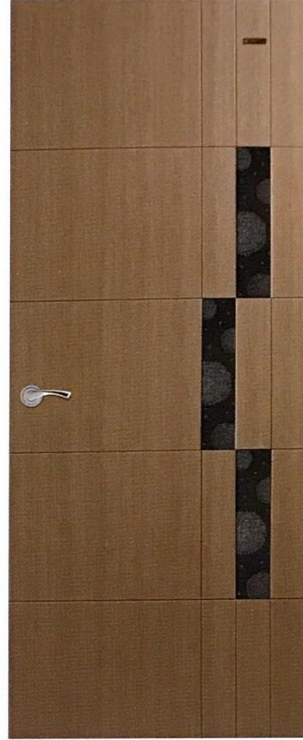

NID060  
 [FZ805] - 만들레 (블랙)



실버로즈



골드로즈



유니크

대한민국 특허청  
 디자인 등록



NID060  
 [UH401] - 실버로즈

대한민국 특허청  
 디자인 등록



NID060  
 [엘리오크] - 골드로즈

대한민국 특허청  
 디자인 등록



NID060  
 [그레이오크] - 유니크

대한민국 특허청  
디자인 등록

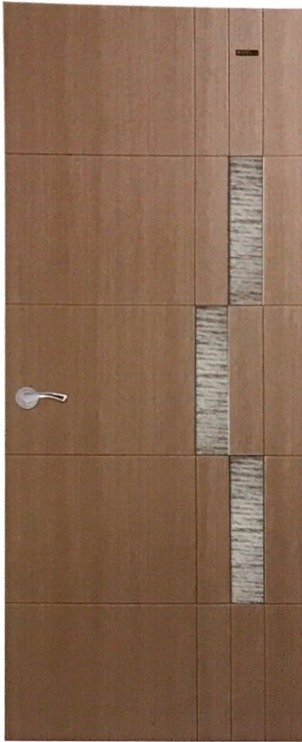

NID060  
[FZ805] - 제브러

대한민국 특허청  
디자인 등록



NID060  
[UH401] - 아네모네

대한민국 특허청  
디자인 등록



NID060  
[그레이오크] - 모자이크

대한민국 특허청  
디자인 등록



NID060  
[FW503] - 잎사귀

대한민국 특허청  
디자인 등록



NID070  
[에다지26] - 크리스탈

대한민국 특허청  
디자인 등록



NID070  
[질백색] - 블랙

대한민국 특허청  
디자인 등록



NID070  
[MW602] - 핑크



크리스탈



블랙



핑크

대한민국 특허청  
 디자인 등록 

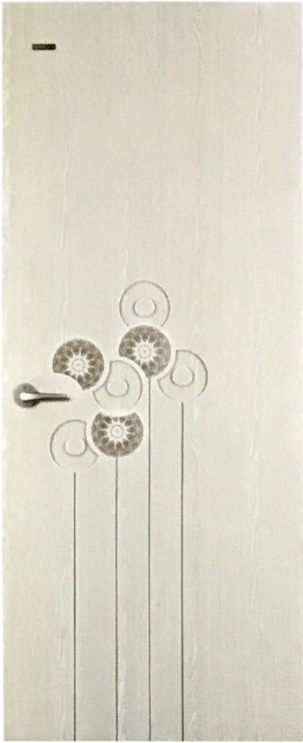

NID080  
 [US201] - 다크

대한민국 특허청  
 디자인 등록 



NID080  
 [아카시아] - 라이트



대한민국 특허청  
 디자인 등록  



NID090  
 [FWS03] - 거울



거울  
 반사되는 거울 포인트

대한민국 특허청  
 디자인 등록  



NID090  
 [UH401] - 블루스타

대한민국 특허청  
 디자인 등록  



NID090  
 [U6405] - 블루스타

대한민국 특허청  
 디자인 등록  



NID090  
 [필백색] - 립베이지

대한민국 특허청  
 디자인 등록  



NID090  
 [그레이오크] - 립베이지



RD170  
[U6406] - 스톤 엠보

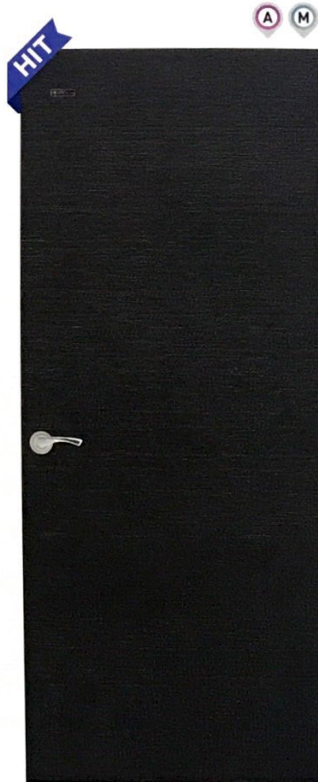

RD170  
[에다지1104] - 스톤 엠보



RD160  
[필백색] - 옷걸 엠보



스톤엠보



스톤엠보

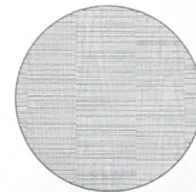

옷걸 엠보



RD160  
[US201] - 옷걸 엠보

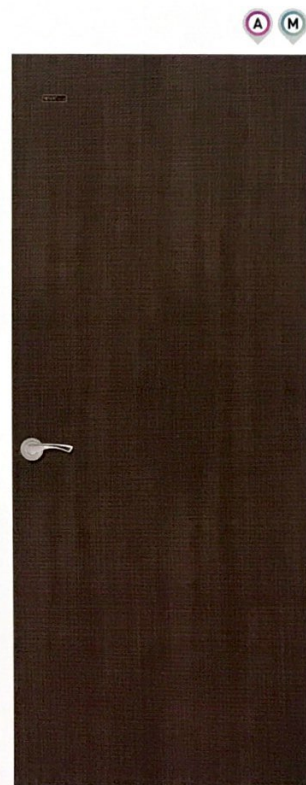

RD161  
[FW503] - 모자이크 엠보



RD161  
[에다지26] - 모자이크 엠보

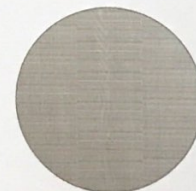

옷걸 엠보



모자이크 엠보

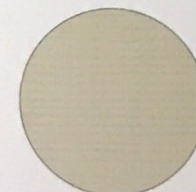

모자이크 엠보



매화



매화



송학



RD140  
[MQ808] - 매화



RD140  
[US201] - 매화



RD141  
[엘리오크] - 송학



송학



대나무



대나무

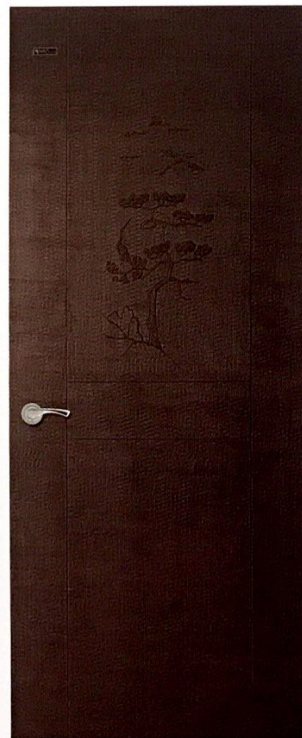

RD141  
[MT127] - 송학



RD142  
[필백색] - 대나무



RD142  
[FZ805] - 대나무



RD143  
[FW503] - 난초



RD143  
[그레이오크] - 난초



RD144  
[아카시아] - 하트



난초



난초



하트

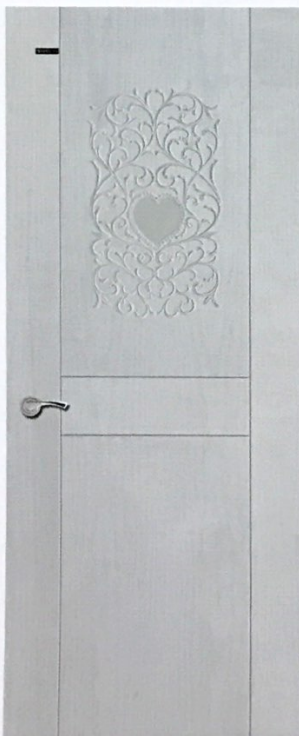

RD144  
[펄백색] - 하트



RD120  
[엘리오크]



RD120  
[US201]



하트



세로결

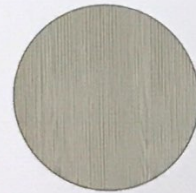

세로결

대한민국 특허청  
디자인 등록



가로결



가로결



RD010

HIT



RD130  
[그레이오크]

HIT



RD130  
[프렌치오크]

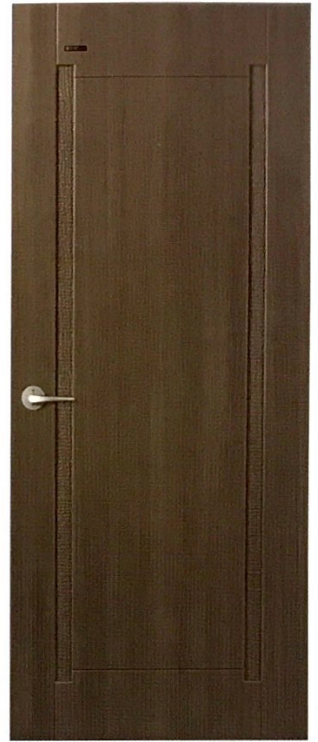

RD010  
[FW503]

대한민국 특허청  
디자인 등록



RD010

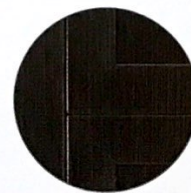

RD030

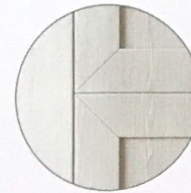

RD030



RD010  
[MW602]

대한민국 특허청  
디자인 등록

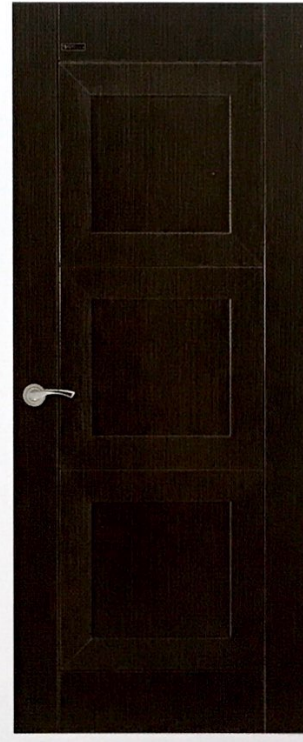

RD030  
[U6405]

대한민국 특허청  
디자인 등록



RD030  
[US201]

네이처 도어 - ABS

DOOR

90 / 91

대한민국 특허청  
디자인 등록



RD030  
[MW602]

대한민국 특허청  
디자인 등록

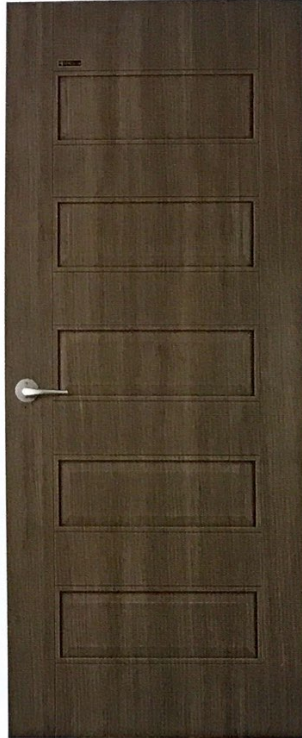

RD050  
[FW503]

대한민국 특허청  
디자인 등록



RD050  
[MQ808]

대한민국 특허청  
디자인 등록



RD050  
[그레이오크]

대한민국 특허청  
디자인 등록



RD060  
[UH401]

대한민국 특허청  
디자인 등록



RD060  
[프렌치오크]

대한민국 특허청  
디자인 등록



RD070  
[필백색]

대한민국 특허청  
디자인 등록

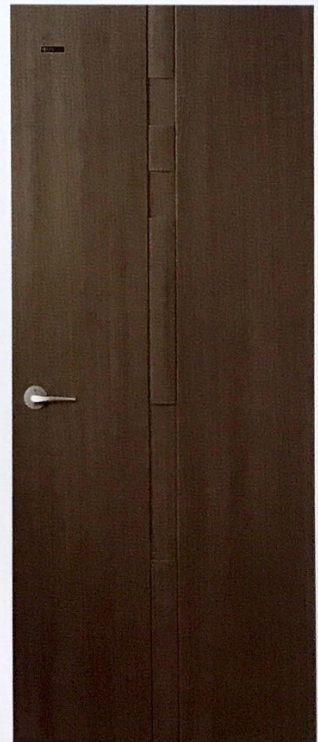

RD070  
[FW503]

대한민국 특허청  
디자인 등록



RD090  
[MQ808]

대한민국 특허청  
디자인 등록



RD090  
[FZ805]

대한민국 특허청  
디자인 등록



RD090  
[아카시아]

대한민국 특허청  
디자인 등록

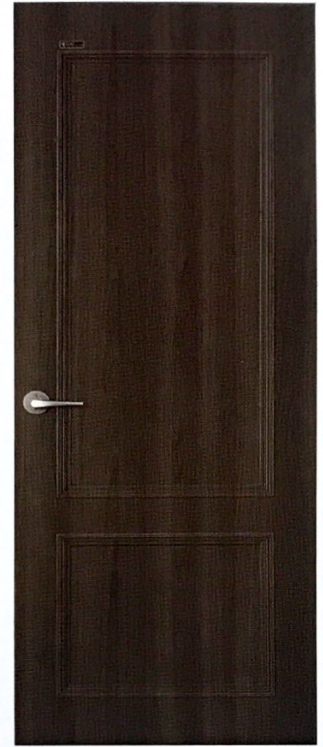

RD110  
[MT127]

대한민국 특허청  
디자인 등록



RD100  
[그레이오크]

대한민국 특허청  
디자인 등록



RD100  
[M0808]

대한민국 특허청  
디자인 등록



RD100  
[U6405]

대한민국 특허청  
디자인 등록

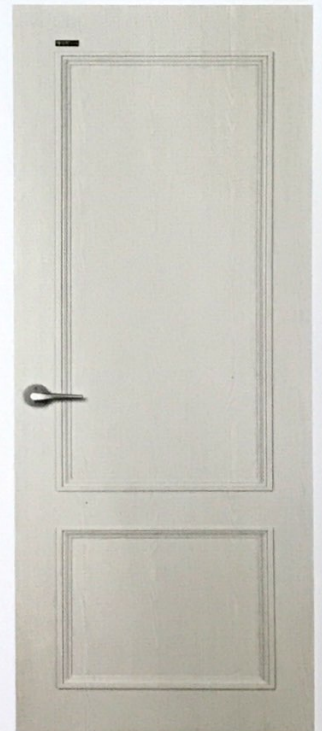

RD110  
[US201]



DN100  
[베다지28]



DN100  
[FZ805]



DN110  
[프렌치오크]

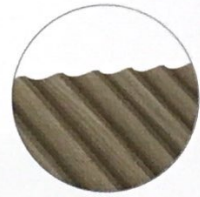

DN100



DN100

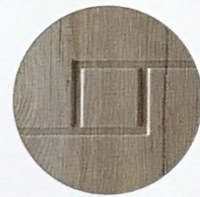

DN110

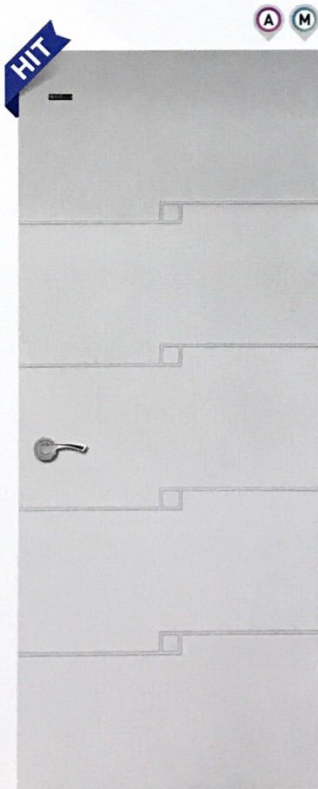

DN110  
[필백색]



DY110-미서기  
[베다지28]

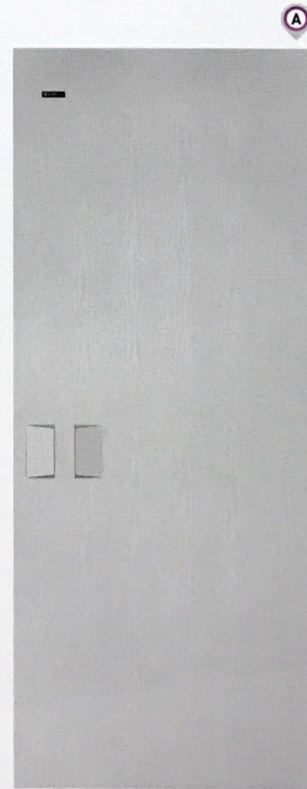

DY110-미서기  
[필백색]

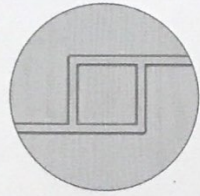

DN110

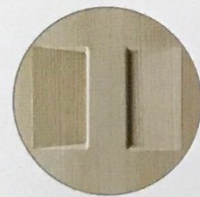

DY110

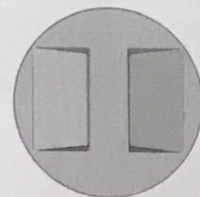

DY110

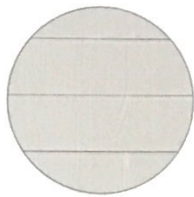

DN080



DN080



DN090

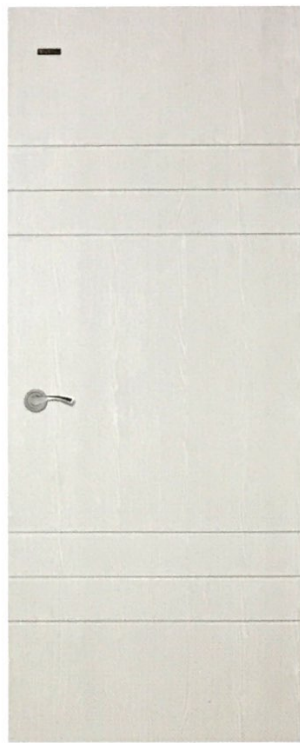

DN080  
[US201]



DN080  
[U6405]



DN090  
[그레이오크]



DV010



DV010

음각과 양각의 교차 표현으로  
 보는 시점에 따라  
 다양한 문양을 표현합니다.



DN090  
[FZ805]



DV010  
[그레이오크]



DV010  
[엘리오크]

대한민국 특허청  
 디자인 등록

대한민국 특허청  
 디자인 등록



평판  
[US201]



평판  
[프렌치오크]



평판  
[필백색]



평판  
[U6405]

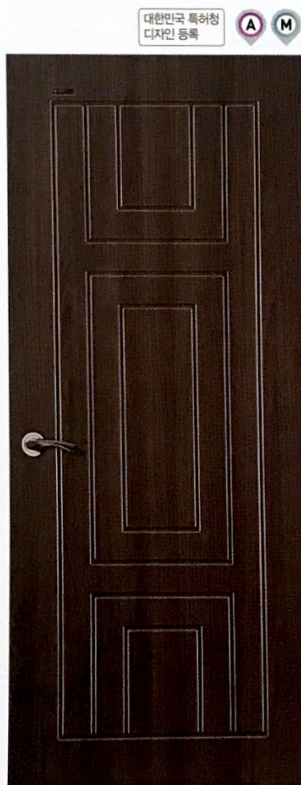

DV070  
[MT127]



RA020  
[엘리오크]



DV030  
[FZ806]



DB010  
[WAL94]

대한민국 특허청  
 디자인 등록



DA020  
 [MQ840]

대한민국 특허청  
 디자인 등록



DA030  
 [예다지38]

대한민국 특허청  
 디자인 등록



RA030  
 [아카시아]

대한민국 특허청  
 디자인 등록



DV050  
 [MQ809]

대한민국 특허청  
 디자인 등록



DN060  
 [MT127]

대한민국 특허청  
 디자인 등록



DN060  
 [WAL94]

대한민국 특허청  
 디자인 등록



DN070  
 [그레이오크]

대한민국 특허청  
 디자인 등록



DY100  
 [엘리오크]

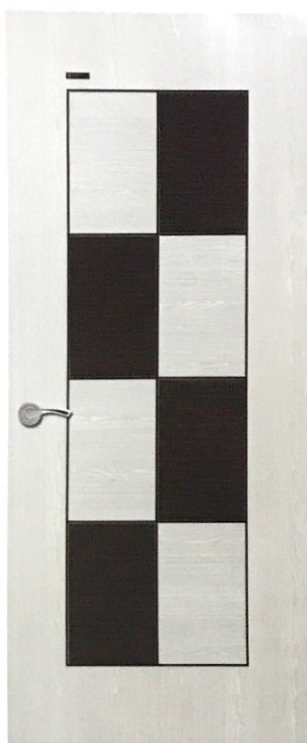

DY040  
[US201] - U6405



DY040  
[FW503] - 펠백색



DY040  
[그레이오크] - 엘리오크

\* 설명항 - 가로줄  
다음 네 가지 골고리 포인트 운용만 가능  
- U6405, 엘리오크, 펠백색, MO808



DY040

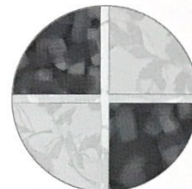

포인트B



블랙펄



DY050  
[US201] - 포인트A



DY050  
[그레이오크] - 포인트B



DY060  
[US201] - 블랙펄



DY060  
[아카시아] - 엘레강스



화이트필



블랙필

고급스러운 블랙필을  
 사용하여 도어에  
 시각적 포인트를 더했습니다.

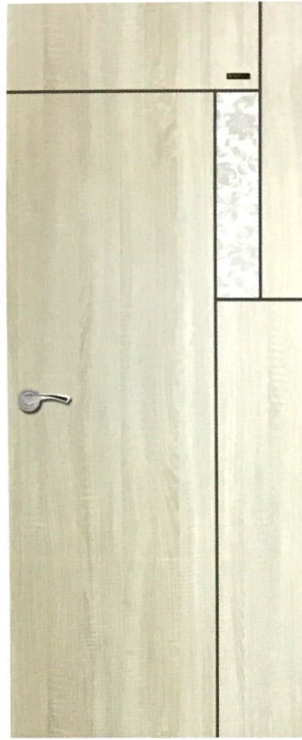

DY060  
 [그레이오크] - 화이트필



DY070  
 [US201] - 블랙필



DY010  
 [예다지104] - WAL94  
 [MO808] - MO809  
 \*기본 피장: 은색  
 다른 컬러 혼합 사용가능

NEW 디렉스 도어 아트 - ABS

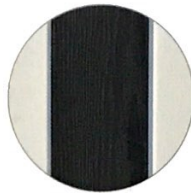

DY010



DY020

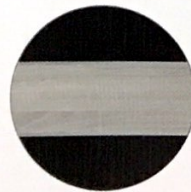

DY030



DY010  
 [US201] - U6405  
 [FZ805] - 그레이오크  
 \*기본 피장: 은색  
 다른 컬러 혼합 사용가능



DY020  
 [그레이오크] - 엘리오크

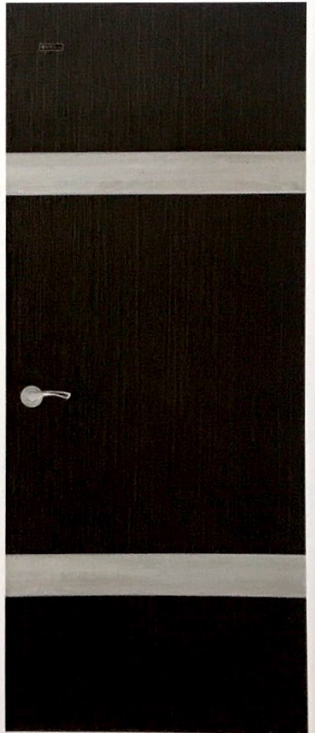

DY030  
 [U6405] - 그레이오크

DOOR

100 / 101



WB160



WB170



WB160  
 [프렌치오크]

\* 타공 사이즈(변경불가) : 200 X 1640



WB170  
 [U6405]



WB180  
 [US201]



WB180



WB190

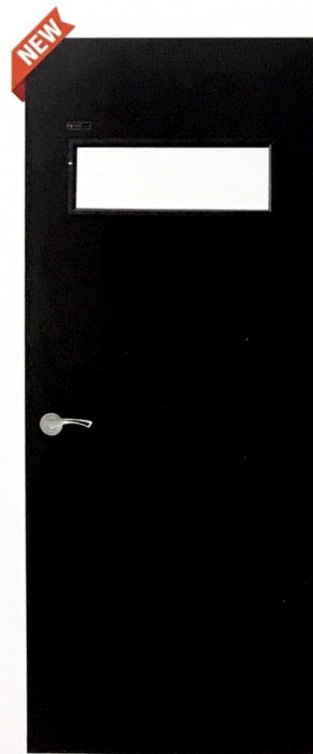

WB180  
 [예다지61]



WB190  
 [필백색]



WB190  
 [예다지104]

ABS도어 or 멤브레인 도어 제작 가능

\*주문시 꼭 ABS, 멤브레인 표시 요망



WB130  
[아카시아]



WB140  
[MQ808]

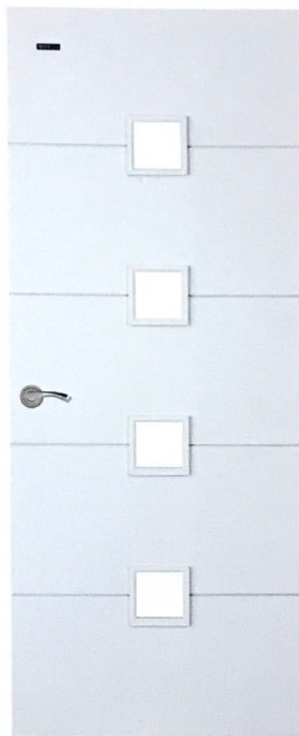

WB150  
[WAL94]



WB020  
[에다지26]



WB030  
[FW503]



WB040  
[그레이오트]



WB050  
[MQ808]



WB060  
[MW602]

멤브레인 도어만 가능



아크릴

\*모델에 부착된 포인트 아크릴은 별도로 구매 가능합니다.



안틱 단조



WB070  
[FZ805]



WB080  
[US201]



WB090  
[FZ805]



WB100 - 1 단조



WB100 - 2 단조

\*단조 포인트는 별도로 구매 가능합니다



WB100  
[프렌치오크]



WB110  
[FW503]



WB120  
[아카시아]

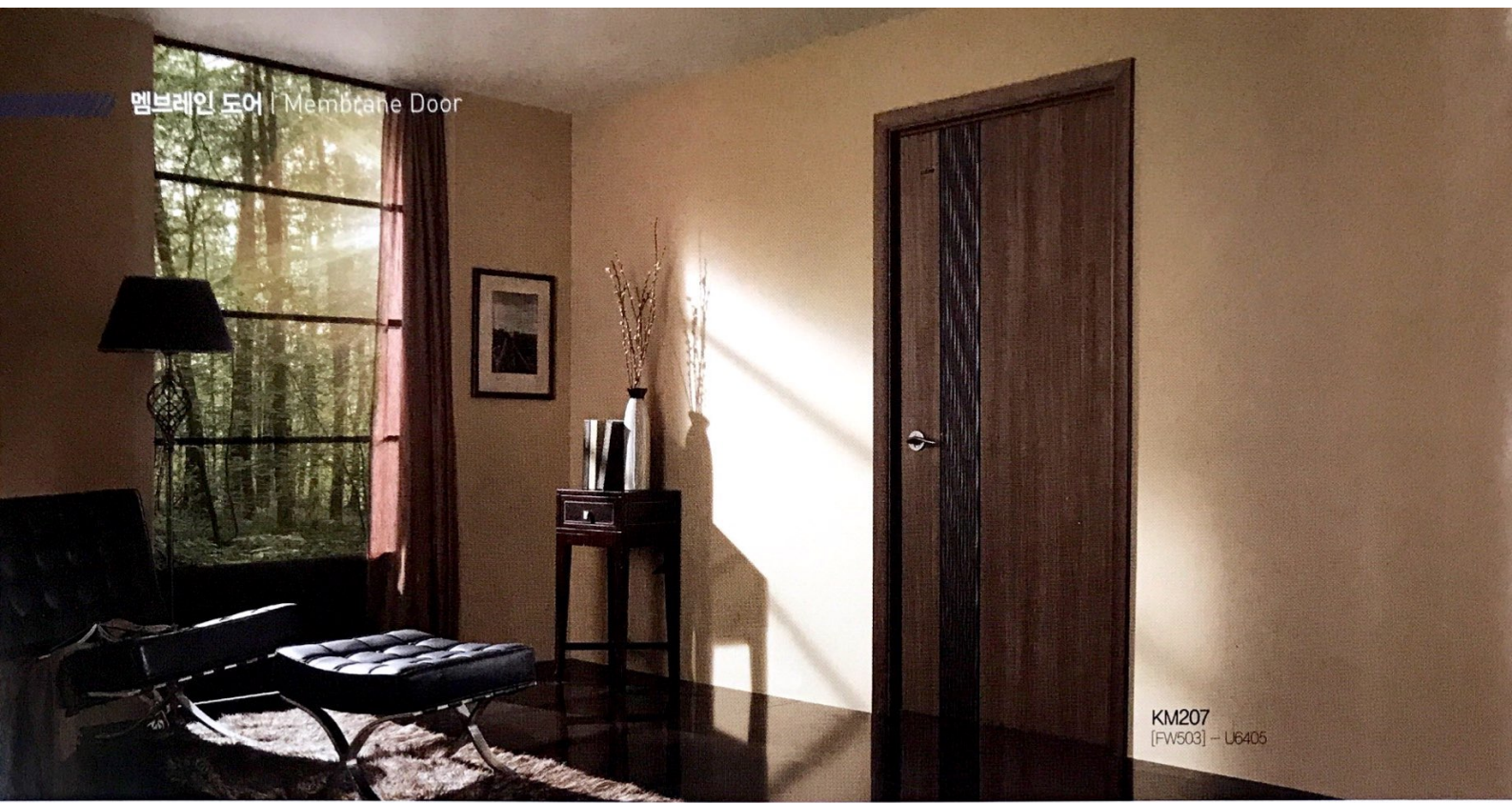

KM207  
[FW503] - U6405

HIT

A



KM410 [네이처-RD100]  
[FW503]

HIT

A



KM411 [네이처-RD110]  
[그레이오크]

HIT

A



KM412 [네이처-RD090]  
[FZ806]

대한민국 특허청  
 디자인 등록



실버패



블랙패



U6405



KM408  
 [US201] - 실버패



KM408  
 [아카시아] - 블랙패



KM201  
 [FW503] - U6405



골드인쇄

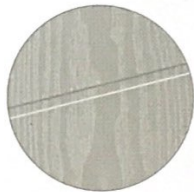

KM110



U6405



KM301  
 [MO808] - 골드인쇄



KM110  
 [팔백색]



KM207  
 [FW503] - U6405

대한민국 특허청  
 디자인 등록



KM202  
[MQ840] - US201



KM070  
[FZ805]



KM405  
[US201] - B 포인트



KM407  
[FW503] - 아카시아



KM014  
[US201]

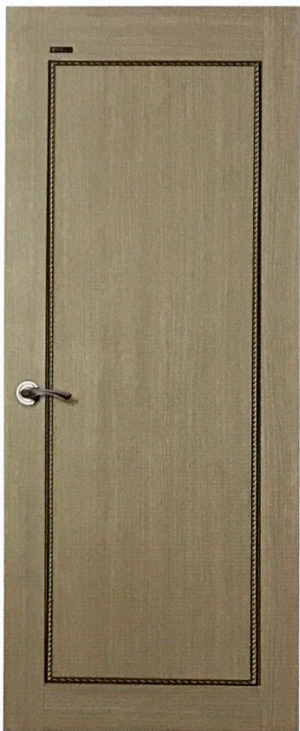

KM014D  
[MQ808]

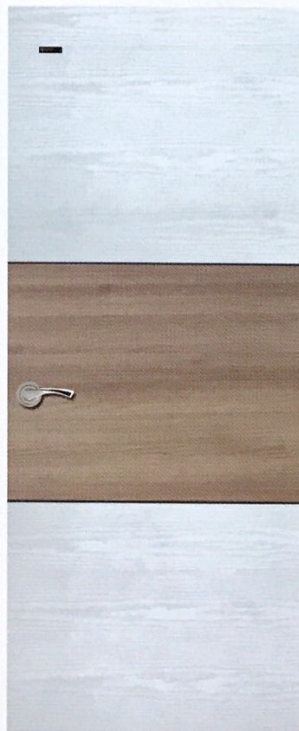

KM030  
[필백색] - 아카시아

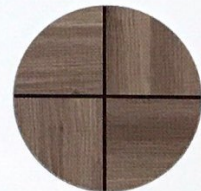

KM407

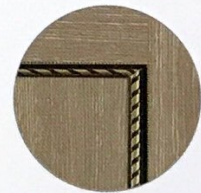

KM014D

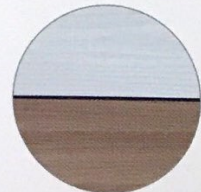

KM030



KM030S  
 [그레이오크] - 엘리오크

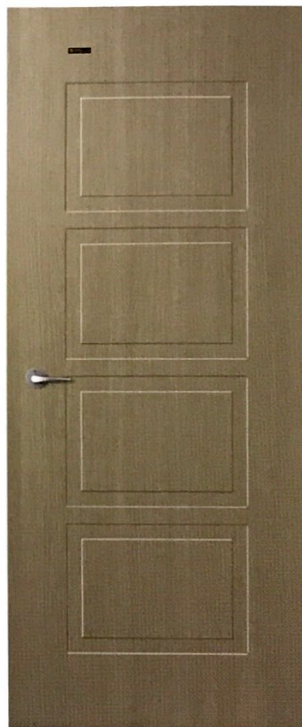

KM040  
 [MG808]



KM050  
 [FZ805]



KM309  
 [U6405] - US201



KM080  
 [FW503]



KM120  
 [예다지28]



KM307  
 [US201] - A 포인트

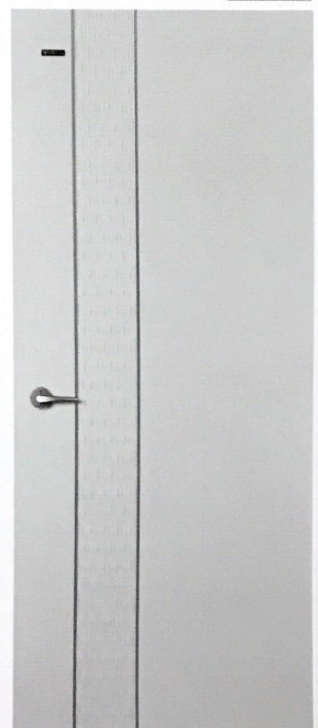

KM206  
 [WAL94]

대한민국 특허청  
 디자인 등록

# Dressroom Door



YDR\_010  
[MQ808]

## 공간 안에 또 다른 공간 창조

드레스룸 도어를 통해 새로운 공간을 만들어 옷을 깔끔하게 보관하고 먼지로 인한 옷의 오염을 방지할 수 있습니다.



\*드레스룸을 비롯해 빌트인 옷장, 와인바, 발코니 수납공간 등 공간 분리가 필요한 모든 곳에 럭셔리한 분위기를 더합니다.  
 \*가구 강철 사용 / 3연동 손잡이 A  
 \*도어 두께 18T  
 \*전 컬러 변경 가능  
 \*도어만 생산가능



YDR\_010  
 [MQ808]

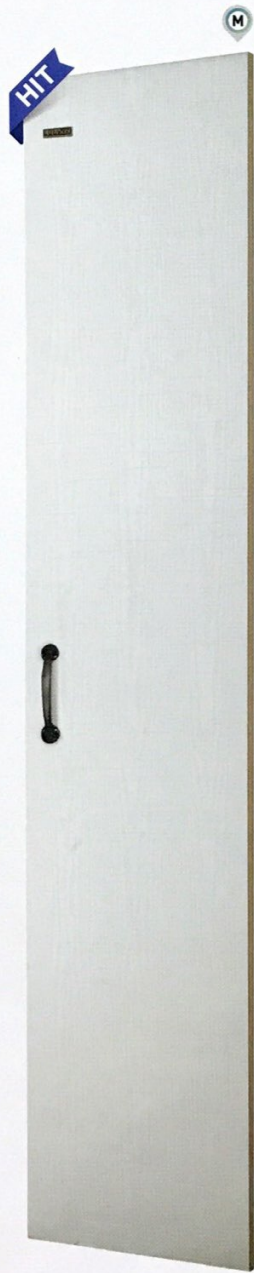

YDR\_020  
 [필백색]



YDR\_030  
 [FZ805]

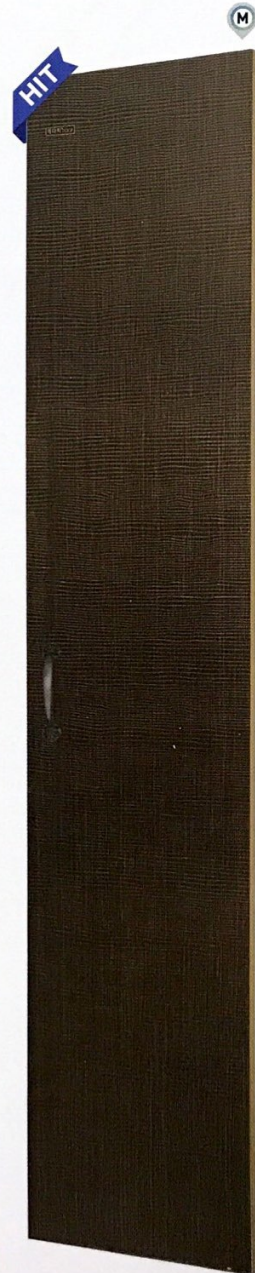

YDR\_040  
 [U6405]

드레스룸 도어

DOOR

110 / 111

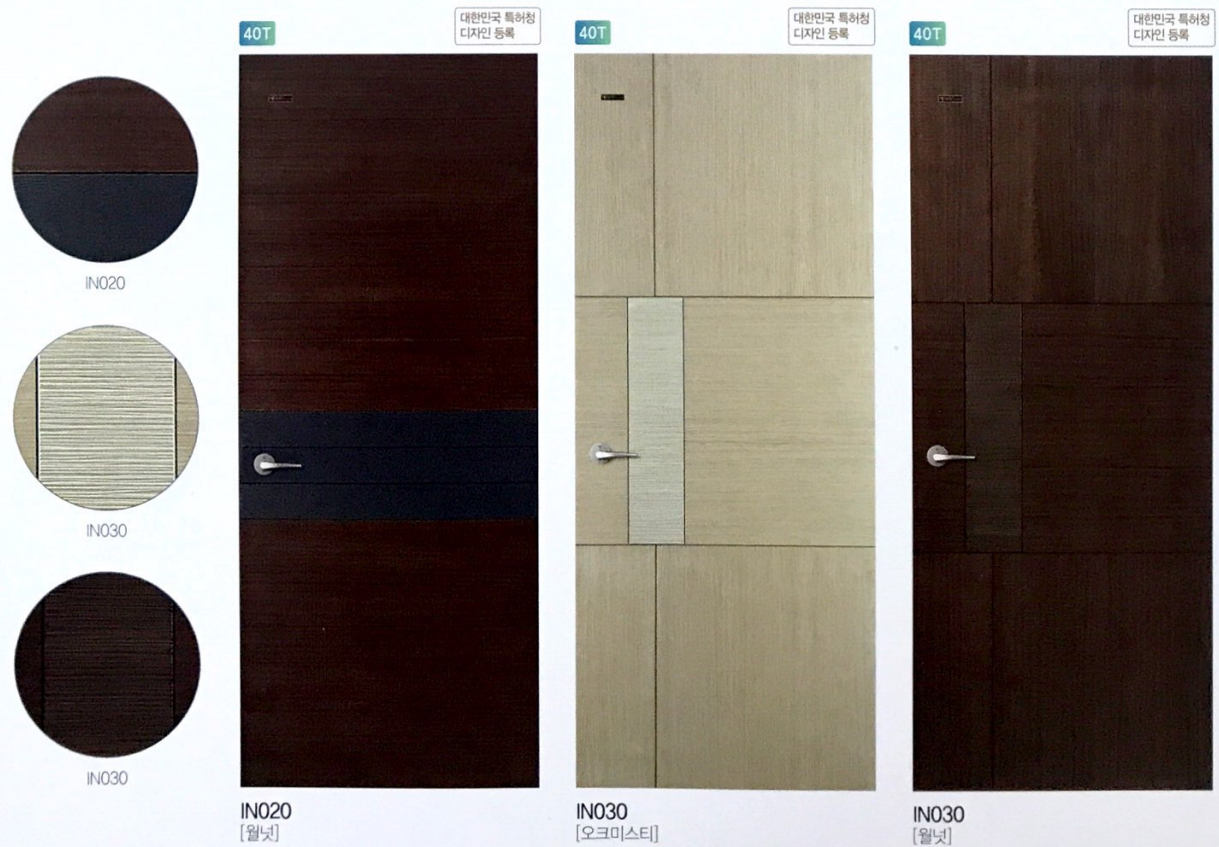

40T

대한민국 특허청  
디자인 등록



IN040  
[오크미스타]

40T

대한민국 특허청  
디자인 등록



IN040  
[월넛]



IN070  
[흑단] - 평판



IN040



IN040



IN070



VN050  
[오크]

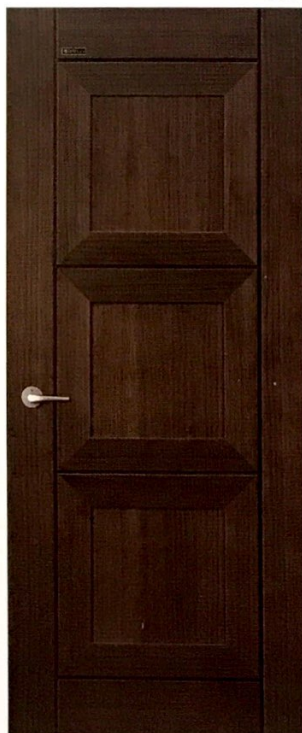

VN070  
[월넛]



VN080  
[월넛]



GOD DESIGN  
지식경제부선정

**'굿디자인  
어워드 수상제품'**

굿디자인 마크는 상품의  
외관, 기능, 경제성 등을  
심사하여 디자인의 우수성이  
인정된 제품에 부여하는  
인증마크입니다.



VA030  
 [체리]



VB030  
 [월넛]

\*천연 무늬목의 특성상 로트벌  
 이색 및 문틀과 도어간 이색이  
 발생할 수 있습니다.  
 \*문틀은 도어와 차이가 날 수 있습니다.  
 (문틀 - 예시)

### ▶ 무늬목 시트 Natural Wood Pattern Sheet ▶

자연느낌의 패턴과 컬러의 예다지 무늬목 시트,  
 당신의 공간 스타일에 맞춰 선택할 수 있습니다.



# Elegance European Luxury Door

## 럭셔리한 도어의 초대

-  
이태리 유명 디자이너의 손길과 최고급 원목이 만나  
지금껏 만나보지 못한 럭셔리한 도어를 창조하다.

EL010



EL030



EL030

## THE ORIGINAL CLASSIC

### 처음 만나는 품격!

예다지가 도어는 다 '거기서 거기'라는 편견을 깨버릴 진짜 유로피안 럭셔리 도어를 선보입니다. 스크래치와 마모에 강한 최고급 원목 만을 선별하여 수준 높은 유로피안 도어를 완성하였습니다. 기존 도어에서 만날 수 없었던 중후한 색감과 오리지널 유럽풍의 패턴은 공간에 우아함을 채우고 최상의 만족감을 선사할 것입니다.

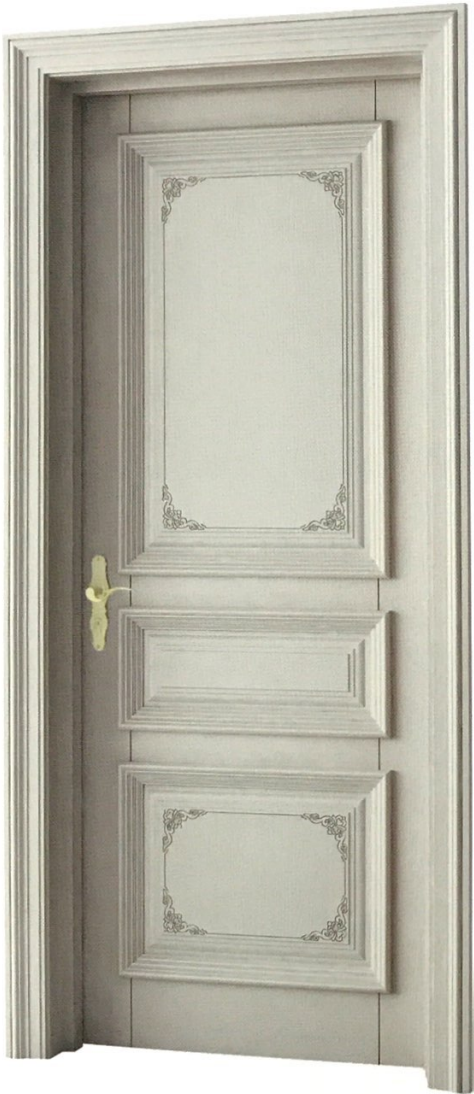

EL010



EL020



EL010

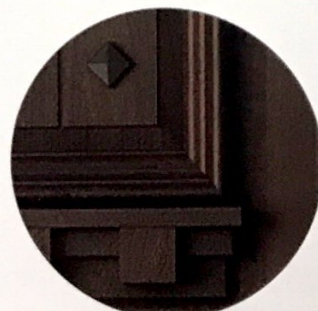

EL020



EL040



EL050

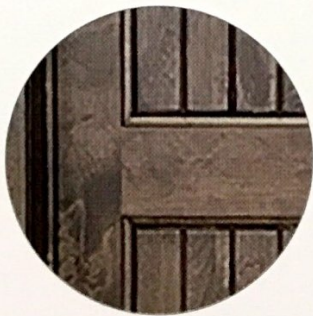

EL040



EL050

# Exterior Door

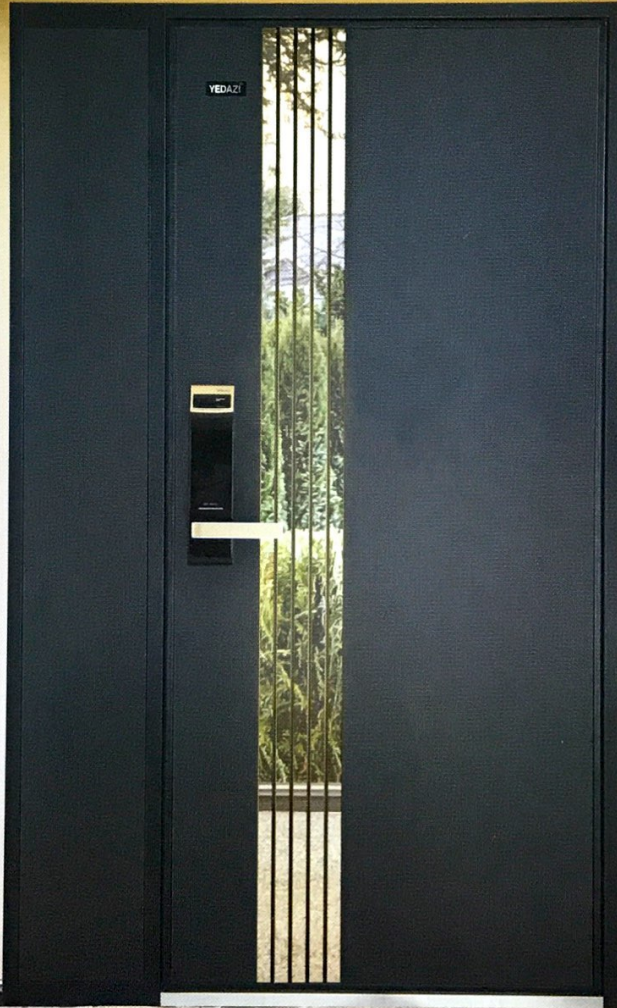

YFD100

## 중후한 인더스트리얼 소재로 현관의 표정을 바꾸다!

현관은 가장 먼저 마주하게 되는 집의 얼굴입니다.  
예다지 현관도어는 '인더스트리얼' 테마를 접목한 깔끔하고  
모던한 설계로 집의 첫인상을 트렌디하게 바꿔줍니다.



YFD100



YFD101



YFD160

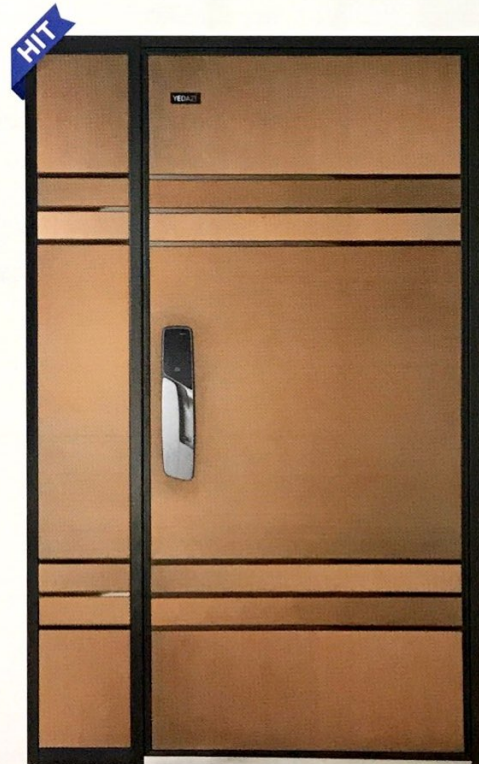

YFD161

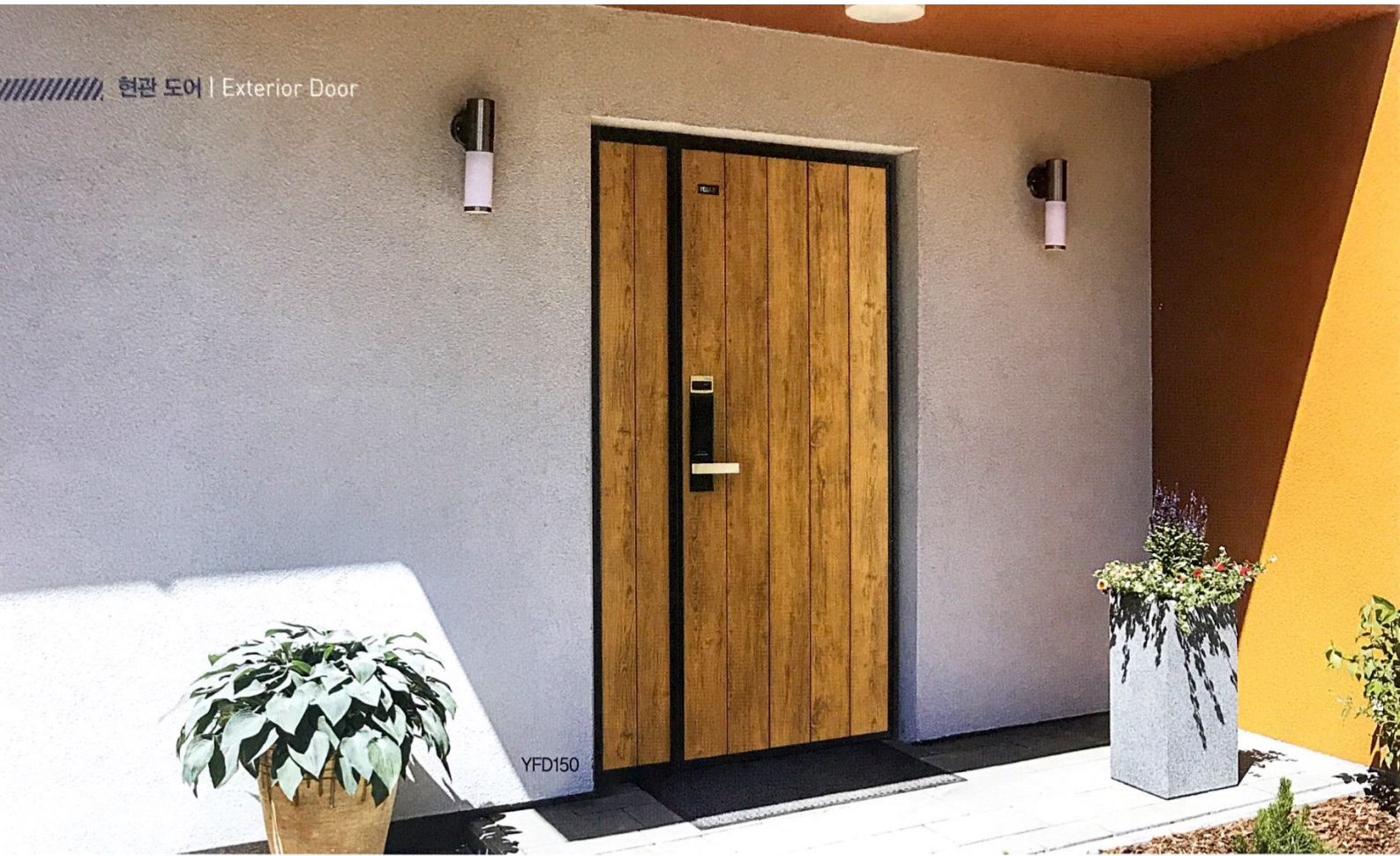

YFD120-1



YFD120-2



YFD120-3



YFD120-4

\*해당컬러 선택가능  
(YFD120만 가능)

HIT



YFD120

HIT

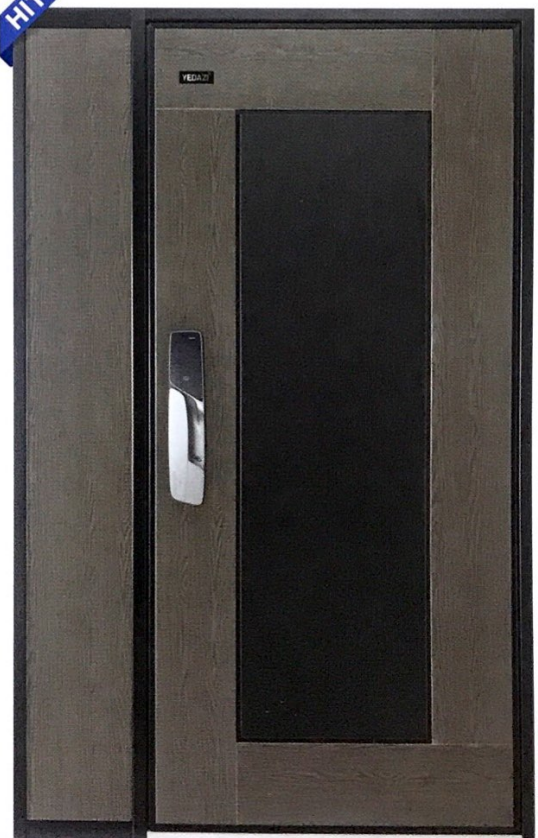

YFD130



GATEMAN A200 GATEMAN F300



YFD140



YFD140



YFD150



YFD110

\* 소대 / 람마 / 양면 일체형



YFD111

\* 소대 / 람마 / 양면 일체형

\*전자도어락 별도 구매

주의사항

- \* 동판, 스텐은 해풍에 녹슬 우려가 있으니 가급적 피해주십시오.
- \* 직접적인 직사광선에 빨리 부식될 수 있으니 주의하십시오.
- \* 표면에 흙이나 페인트가 묻지 않도록 주의하십시오.
- \* 표면에 이물질이 묻을 시 신나 등 화학제품으로 닦지 마십시오.
- \* 이물질이 묻었을 시 즉시 극세사 면걸레로 제거해 주시기 바랍니다. (유리세정제 등을 뿌린 후)
- \* 표면이 약하므로 날카로운 물질에 주의하십시오.
- \* 테이프 등을 붙이지 마십시오.
- \* 문을 장시간 열어두지 마십시오. (바람에 의해 갑자기 닫혀 도어클로저 파손의 우려가 있습니다.)
- \* 도어락에 매달리지 마십시오.
- \* 문틀에 걸려 넘어질 수 있으니 주의하십시오.
- \* 보양재는 가급적 사용 전에 제거해 주십시오.

# Silk Printing Door-ABS

## 공간에 은은한 빛이 내리다

-  
다양한 소재의 실크 패턴이 빛의 방향에 따라  
은은하게 반사되어 특별한 감동을 선사합니다.

SP010  
[그레이오크] - 나이트

A ABS도어 가능  
 M 멤브레인도어 가능

\*해당 모델, 해당 컬러만 가능



SP020  
 [필백색] - 나뭇잎

SP030  
 [FW503] - 아자수



나이테

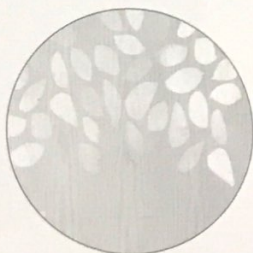

나뭇잎



아자수



문을 열면  
아이의 꿈도 열립니다

- 귀여운 동물과 캐릭터, 아이들이 좋아하는 알록달록한 컬러가 아이들의 꿈과 상상력을 밝혀줍니다.

YKD080  
[에다지102-연두색] 로봇

A

A



YKD070  
[에다지101-노랑색] 호랑이



YKD080  
[에다지102-연두색] 로봇

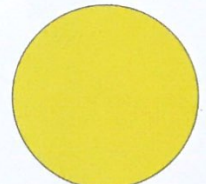

에다지101-노랑색



에다지102-연두색



에다지103-하늘색



에다지116-분홍색

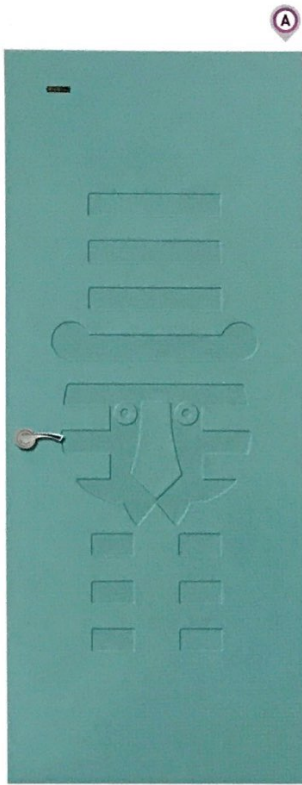

YKD070  
 [예다지103-하늘색] 호랑이

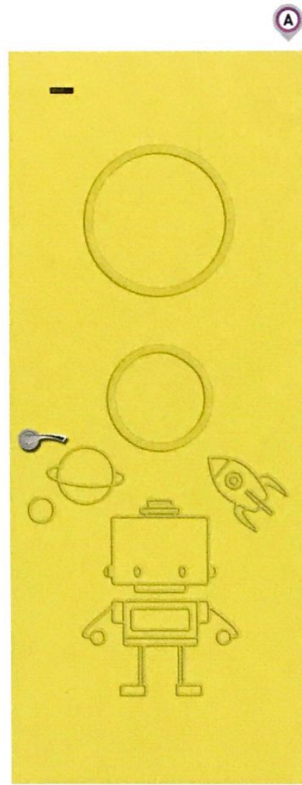

YKD080  
 [예다지101-노랑색] 로봇

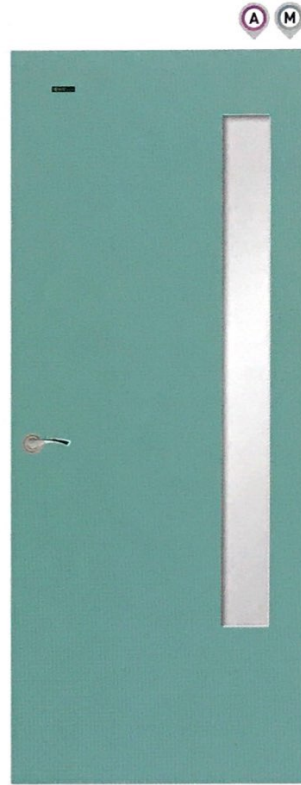

YKD010  
 [예다지103-하늘색]

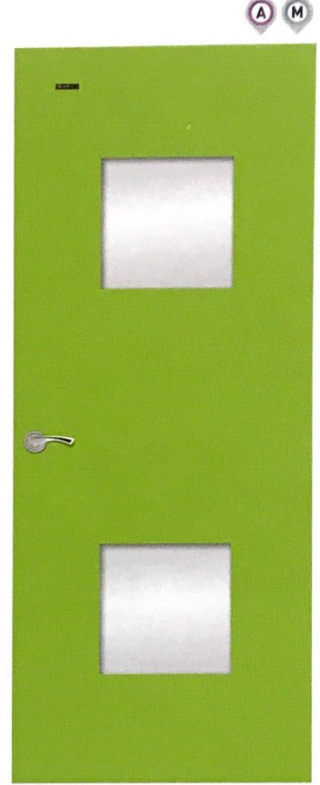

YKD020  
 [예다지102-연두색]



YKD030  
 [예다지101-노랑색]

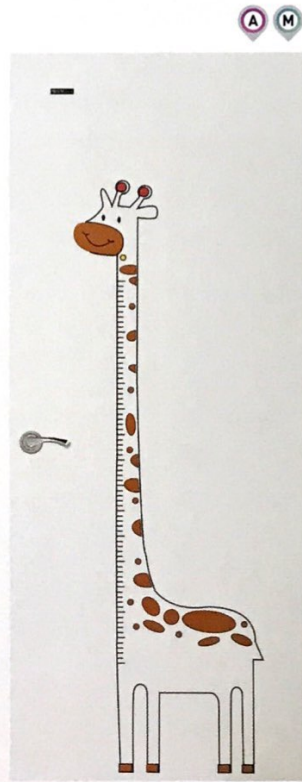

YKD040  
 [WAL94] - 흰기린



YKD050  
 [WAL94] - 주황기린

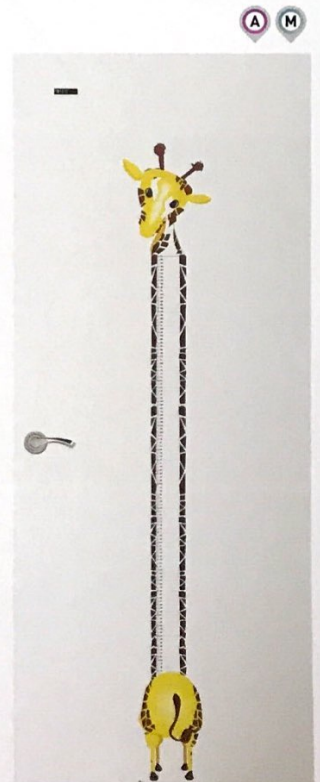

YKD060  
 [WAL94] - 노랑기린

제품 표기법  
**제품명**  
[제품컬러]  
전 도어  
컬러 변경 가능  
\*전제품 기본 : 투명 유리

HIT

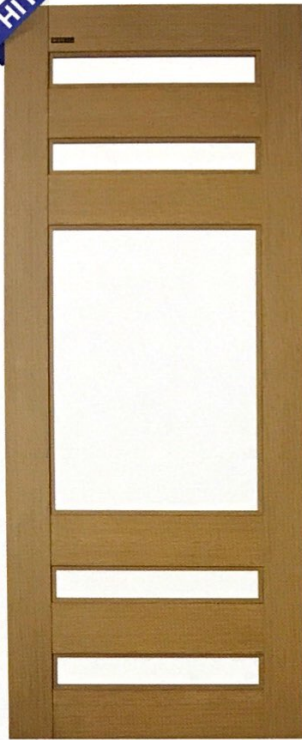

KG190  
[M3701]

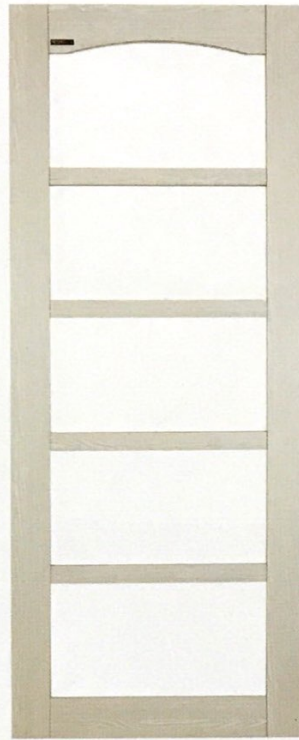

KG140  
[US201]

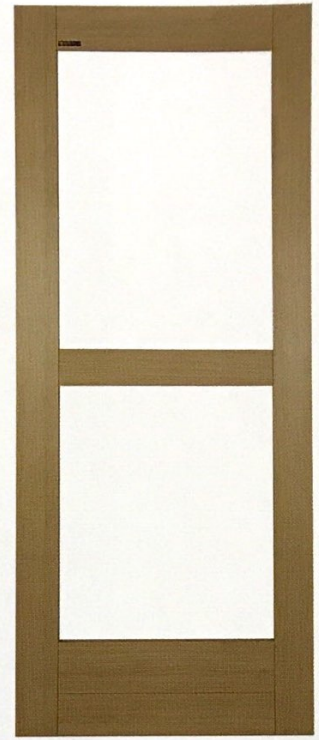

KG150  
[MQ808]

공간과 공간을 연결해주는  
미서기 도어는 아름다움을 더하며  
실내를 더욱 넓게 사용할 수 있습니다.

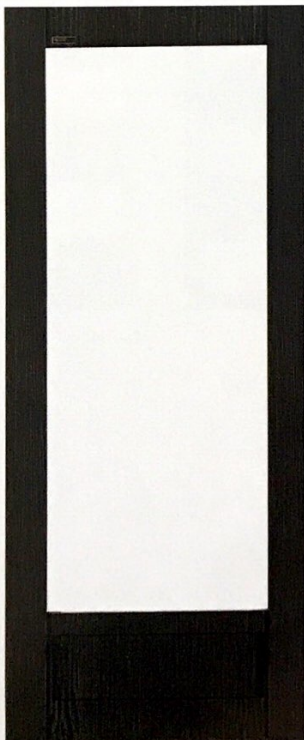

KG160  
[U6405]

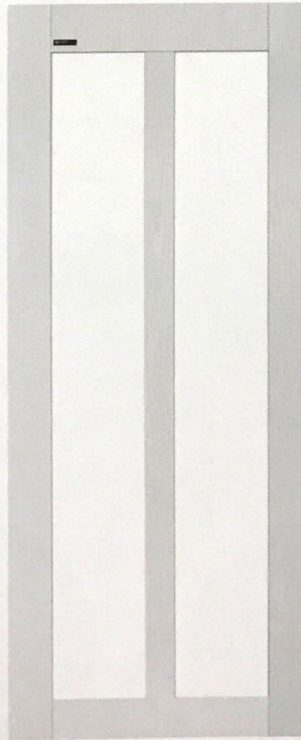

KG170  
[펄백색]

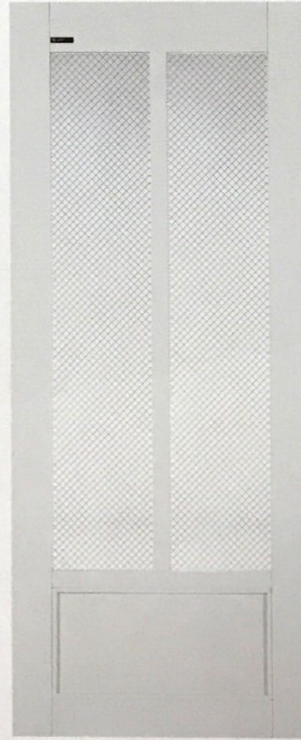

KG180  
[WAL94] - 망입(KYG096)



KG010  
[FZ805] - 워터큐브



KG020  
[FW503]

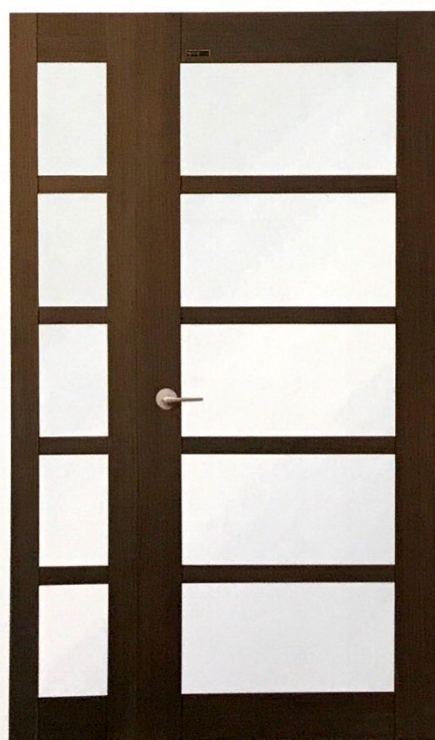

KG030  
[FW503]

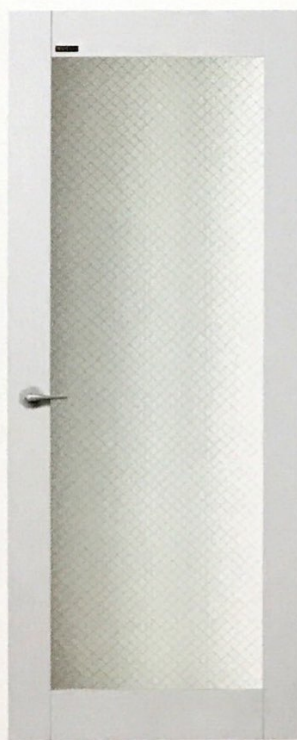

KG040  
[WAL94] - 불투명 망입(KYG114)



KG050  
[FW503]

HIT

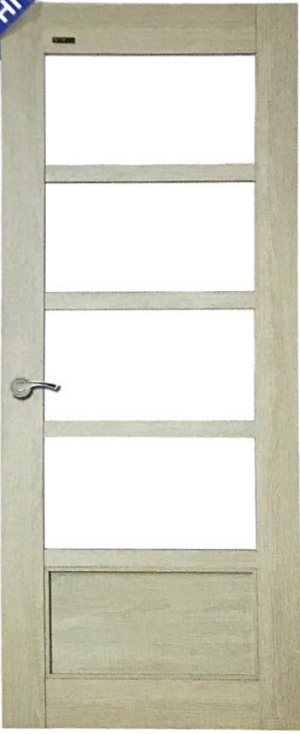

KG060  
[그레이오크]



KG070  
[FZ805]



KG080  
[MW602]



KG090  
[아카시아]

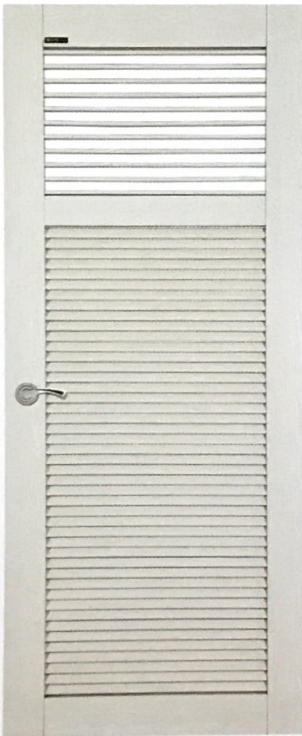

KG130  
[US201] - 수평 + 막힌 갤러리



KG100  
[MT127]



KG110  
[MW602] - 막힌 갤러리

제품 표기법  
**제품명**  
[제품컬러]  
전 도어  
컬러 변경 가능



KG120  
[MW602] - 막힌 갤러리



KY001  
[MQ808]



KY002  
[MW602]

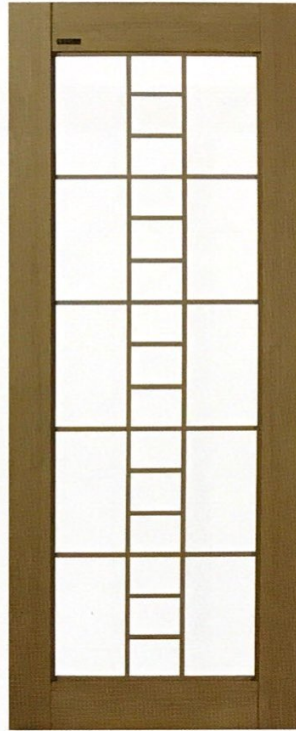

KY003  
[FZ805]

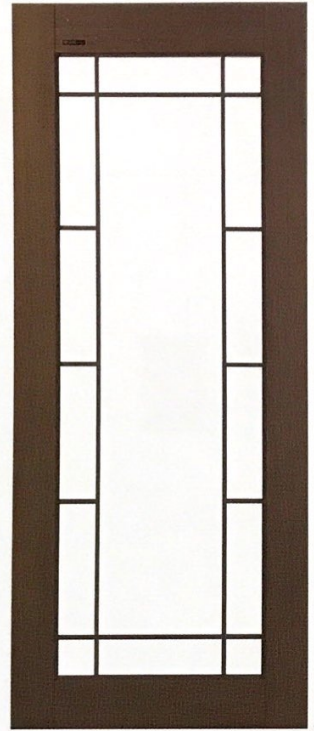

KY004  
[FW503]

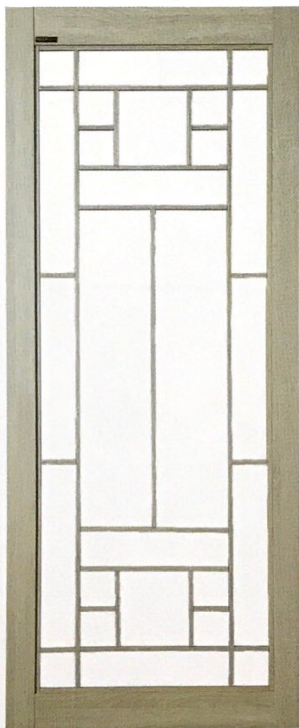

KY005  
[그레이오크]



KY006  
[FZ805] - A(국화)

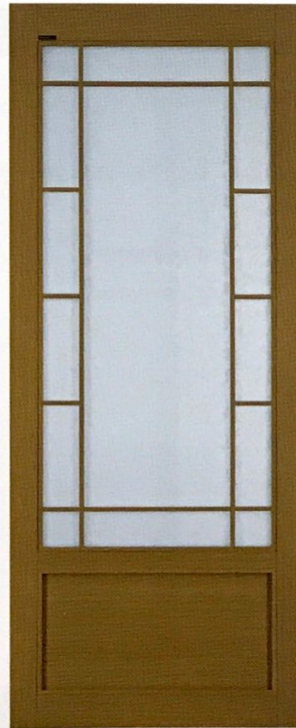

KY007  
[FZ805] - B(당굴)

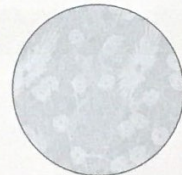

A (국화)

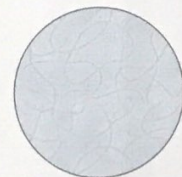

B (당굴)

한지에서 느낄 수 있는  
 전통문의 아름다움을  
 그대로 디자인했습니다

\*전제품 기본 : 투명유리 \*살 종류 : 라왕

데코레이션 • 3연동 ▶ 투명한 유리 위에 한폭의 예술을 수 놓다



현대적인 패턴을 적용해  
미적 감각을 더 했습니다.



KYG139  
[예다지118] - 조립 베벨드

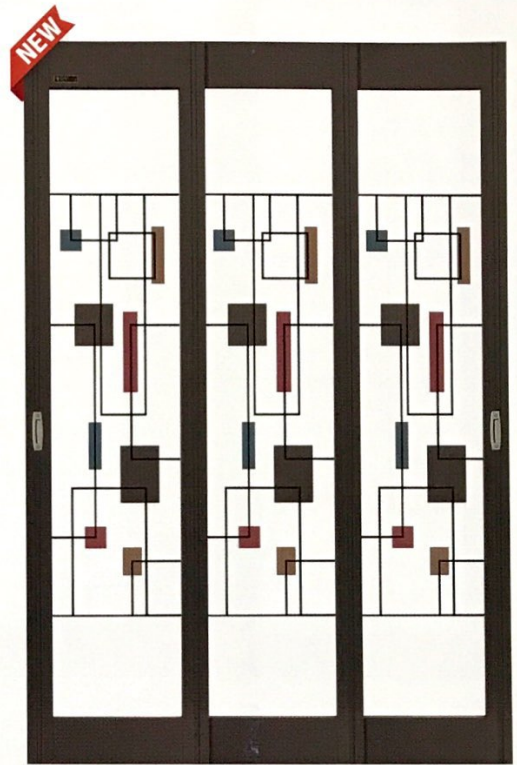

KYU023  
[예다지118] - UV인쇄

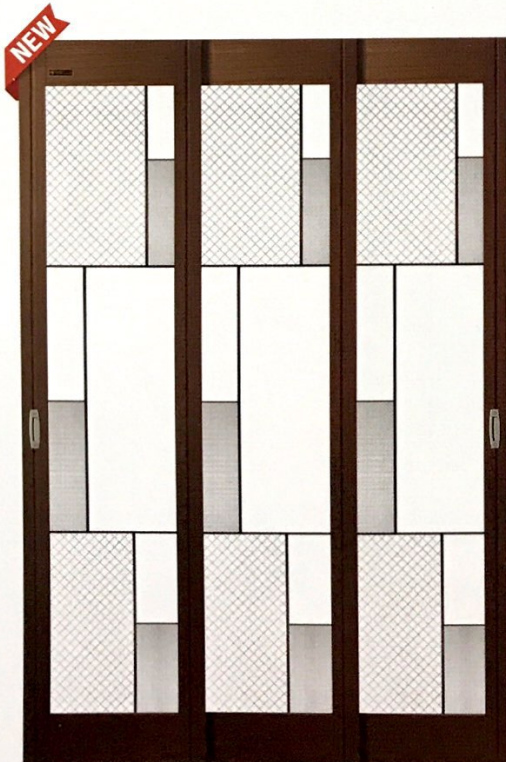

KYU024  
[FW503] - UV인쇄



KYU025  
[예다지104] - UV인쇄

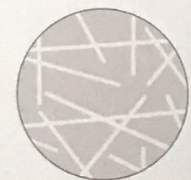
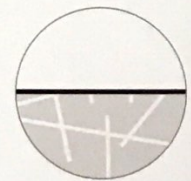
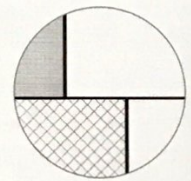

반복적 패턴과 라인 디자인  
이 모던한 스타일입니다.

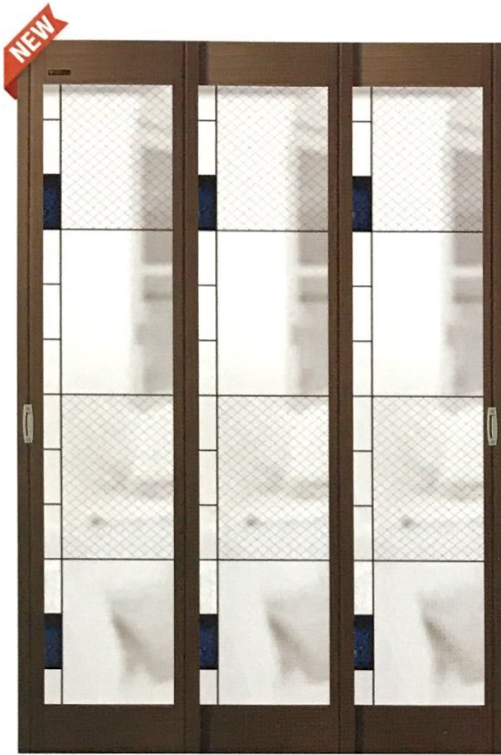

KYU026  
 [FW503] - UV인쇄



KYU027  
 [에다지34] - UV인쇄

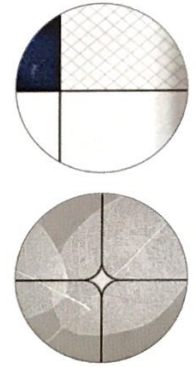

사선과 나뭇잎의 세밀한 디자인 표현이 돋보입니다.

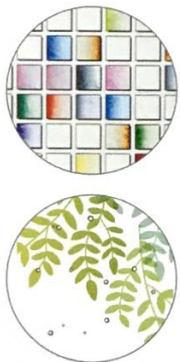

화려한 컬러 배치가 눈을 한 번에 사로잡습니다.



KYU012  
 [WAL94] - UV인쇄



KYU014  
 [에다지34] - UV인쇄

\*전제품 기본 : 투명유리 \*비규격 / 주문형 모델 주문제작 가능합니다. \*품질 향상을 위해 디자인은 사전 예고 없이 변경될 수 있습니다. \*작업 사양에 따라 제품 규격 및 문양 색상이 변경될 수 있습니다.

데코레이션 • 3연동 ▶ 다양한 디자인의 각기 다른 스타일로 선택의 폭을 넓혔습니다



라인 강조를 통해 유러피안 스타일을 재현하였습니다



KYU015  
[예다지104] - UV인쇄



KYU016  
[예다지115] - UV인쇄



KYU017  
[예다지34] - UV인쇄 보석



KYU018  
[예다지118] - UV인쇄

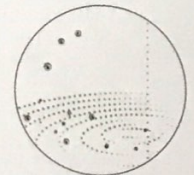

자연의 생생함을 담았습니다.

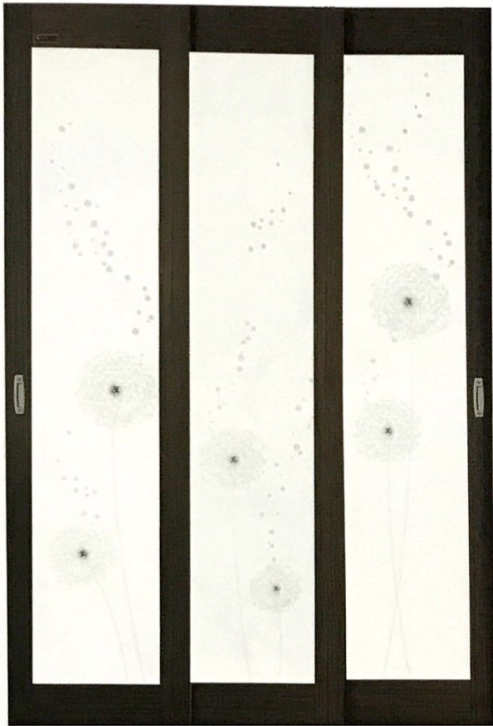

KYU001  
 [U6405] - UV인쇄



KYU002  
 [예다지118] - UV인쇄

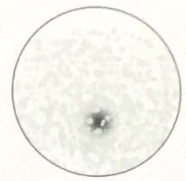

자연의 작은 디테일까지  
 예술적으로 표현하였습니다.

데코레이션 도어

DOOR

154 / 155



은은한 컬러가 주는  
 화사함이 돋보입니다



KYU003  
 [예다지34] - UV인쇄

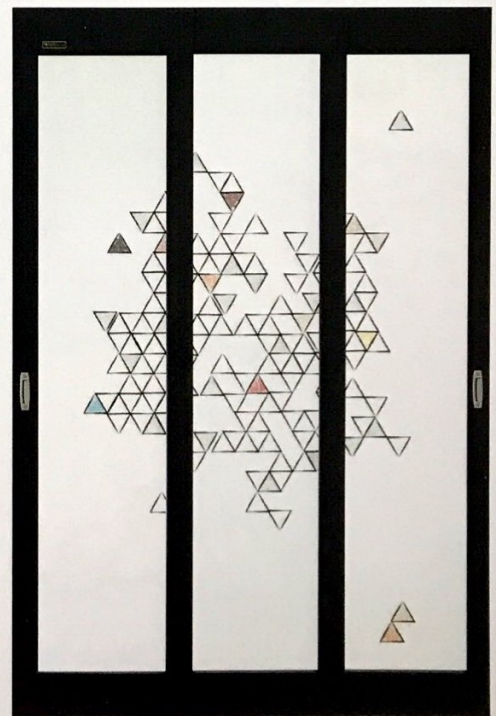

KYU004  
 [예다지104] - UV인쇄

\*전제품 기본 : 투명유리 \*비규격 / 주문형 모델 주문제작 가능합니다. \*품질 향상을 위해 디자인은 사전 예고 없이 변경될 수 있습니다. \*작업 사양에 따라 제품 규격 및 문양 색상이 변경될 수 있습니다.

데코레이션 · 3연동 ▶ 우리집 도어에 화사한 봄을 입히다



봄을 만나듯 집 안도  
새롭게 피어납니다.



KYU006  
[예다지34] - UV인쇄



KYU007  
[FW503] - UV인쇄



KYU008  
[U6405] - UV인쇄



KYU009  
[FW503] - UV인쇄 보석

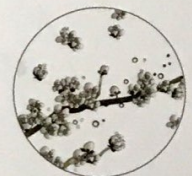

싱그러운 봄의 생생함을  
표현하였습니다.

HIT



KYU011  
 [예다지34] - UV인쇄



KYG060  
 [U6405] - UV인쇄



만개한 꽃과 향기의  
 이미지를 표현하였습니다

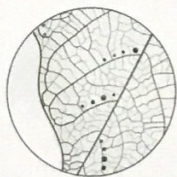

나뭇잎을 라인과 컬러를  
 강조하여 디테일하게  
 표현했습니다



KYG062  
 [예다지118] - UV인쇄

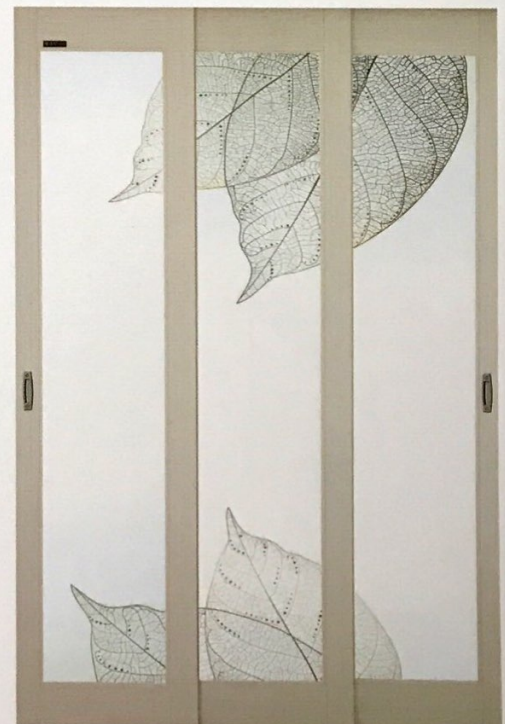

KYG064  
 [예다지34] - UV인쇄

\*전제품 기본 : 투명유리 \*비규격 / 주문형 모델 주문제작 가능합니다. \*품질 향상을 위해 디자인은 사전 예고 없이 변경될 수 있습니다. \*작업 사양에 따라 제품 규격 및 문양 색상이 변경될 수 있습니다.

데코레이션 • 3연동 ▶ 보기에만 좋은 것보다 공간과의 조화를 먼저 생각합니다

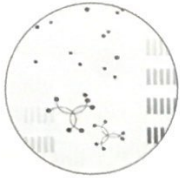

꽃의 아름다움을 모던하게  
승화시켜 밝고 화사한  
이미지를 더합니다.



KYG066  
[U6405] - UV인쇄



KYG067  
[U6405] - UV인쇄



KYG100  
[U6405] - 차밍(아쿠아+투명+아쿠아)



KYC001  
[에다지115] - 차밍

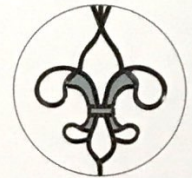

문양과 캐릭터가 돋보이는  
유니크한 도어입니다



KYC002  
 [예다지34] - 차밍



KYB013  
 [U6405] - 보석 + UV인쇄



안정감과 편안함이  
 느껴지는 컬러와  
 레이아웃을 적용하였습니다



꽃잎을 컬러와 패턴의  
 적절한 조화로 아름답게  
 형상화하였습니다.



KYB014  
 [예다지34] - 보석 + UV인쇄



KYB015  
 [예다지34] - 에칭 보석

\*전제품 기본 : 투명유리 \*바규격 / 주문형 도넛 주문제작 가능합니다. \*품질 향상을 위해 디자인은 사전 예고 없이 변경될 수 있습니다. \*작업 사양에 따라 제품 규격 및 문양 색상이 변경될 수 있습니다.

데코레이션 • 3연동 절제와 심플함으로 모던한 감각을 극대화하였습니다



바로크 문양을 음각과 양각으로 입체적으로 표현했습니다



KYB016  
[FW503] - 에칭 보석



KYB017  
[에다지34] - 에칭 보석



KYB010  
[U6405] - 라이팅글라스+보석



KYG112  
[U6405] - 베벨드

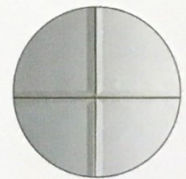

원과 선을 이용한 깔끔 그자체  
어떤 실내 인테리어와도  
잘 어울립니다

3연동 도어  
 개방시  
 포인트  
 조합



KYG101 [크리스탈 포인트]  
 [U6405]

KYG102 [크리스탈 포인트]  
 [예다지118]

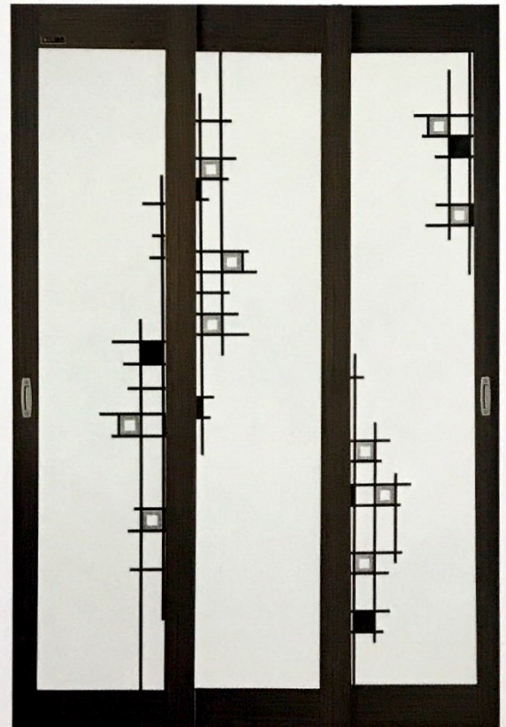
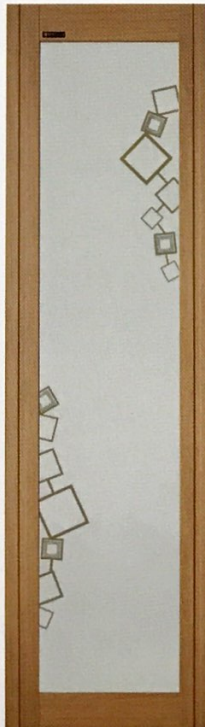
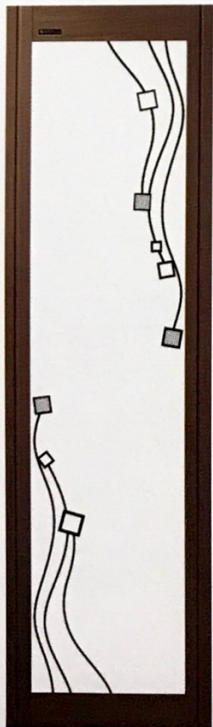

KYD091 [크리스탈 포인트]  
 [FW503]

KYD092 [크리스탈 포인트]  
 [FW503]

KYD093 [크리스탈 포인트]  
 [MW602]

KYD094 [크리스탈 포인트]  
 [U6405]

\*전제품 기본 : 투명유리 \*비규격 / 주문형 모델 주문제작 가능합니다. \*품질 향상을 위해 디자인은 사전 예고 없이 변경될 수 있습니다. \*작업 사양에 따라 제품 규격 및 문양 색상이 변경될 수 있습니다.

데코레이션 • 3연동 디자인과 소재의 완벽한 하모니를 경험하세요



기하학적 문양과 패턴의 조화가 멋스러운 도어입니다



KYD122  
[예다지118] - 펄 페어



KYD123  
[FW503] - 보석 펄 페어



KYD124  
[예다지34] - 보석 페어



KYD125  
[예다지34] - 크리스탈 페어



보석과 크리스탈이 주는 반짝이는 포인트가 돋보입니다



KYD095  
 [U6405] - 펠 페어



KYD096  
 [U6405] - 펠 페어

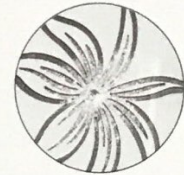
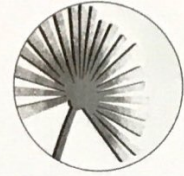

펠 단조 포인트로  
 기존의 단조 도어와  
 차별화하였습니다.



화려한 디자인으로  
 모던함을 더합니다.



KYD097  
 [U6405]



KYD098  
 [예다지34] - 나비아크릴 페어

\*전제품 기본 : 투명유리 \*비규격 / 주문형 모델 주문제작 가능합니다. \*품질 향상을 위해 디자인은 사전 예고 없이 변경될 수 있습니다. \*작업 사양에 따라 제품 규격 및 문양 색상이 변경될 수 있습니다.

데코레이션 • 3연동 ▶ 수목화를 닮은 섬세한 라인 터치로 동양미를 더하다



우아한 곡선이 세련된  
품격을 보여줍니다



KYD099  
[에다지34]



KYD028  
[FW503]



KYD029  
[FW503]



KYD030  
[FW503]



KYD032  
 [FW503]



KYD034  
 [FW503]

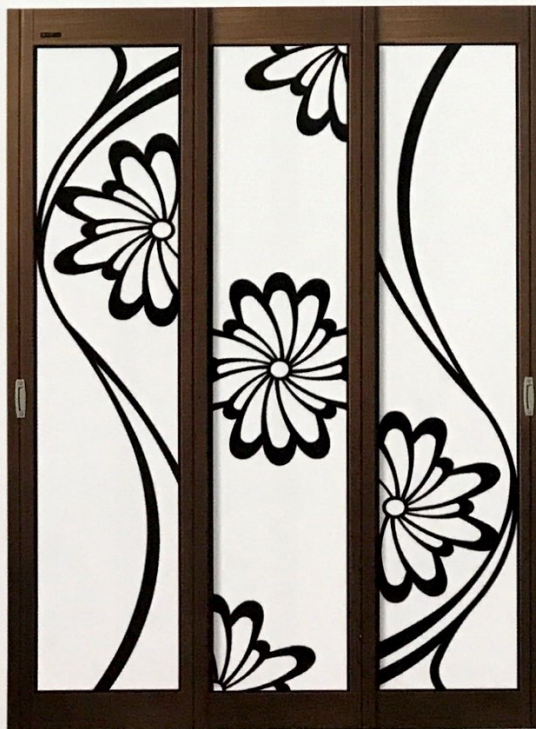

KYD035  
 [FW503]



KYD079  
 [FW503]

\*전제품 기본 : 투명유리 \*비규격 / 주문형 모델 주문제작 가능합니다. \*품질 향상을 위해 디자인은 사전 예고 없이 변경될 수 있습니다. \*작업 사양에 따라 제품 규격 및 문양 색상이 변경될 수 있습니다.

데코레이션 • 3연동 ▶ 선과 색, 그리고 여백이 아름다운 조화를 이룹니다



황동 특유의 아름다움이  
묻어나는 고품격 단조입니다



KYD081  
[FW503] - 황동단조



KYD082  
[U6406] - 투톤단조

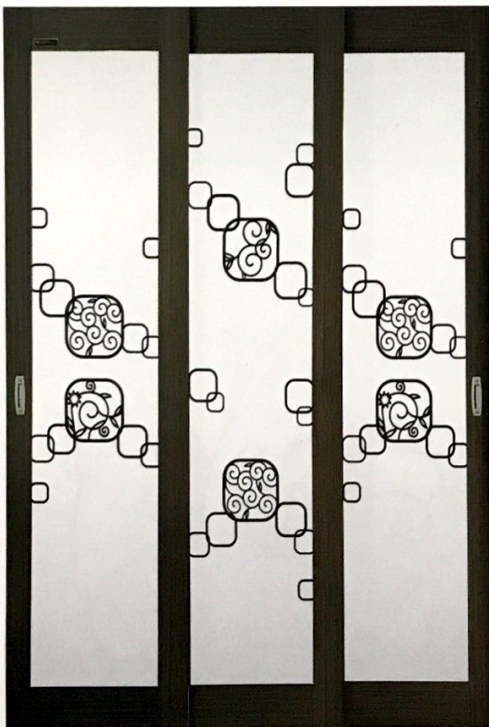

KYD083  
[U6406]



KYG016  
[FW503] - 펠단조 페어



KYG017  
[예다지115] - 펠단조 페어

## 기본부터 튼튼한 예다지! 뛰어난 내수성과 품질을 자랑합니다

특수 발포 프레임 PVC, 구조 보강재 등을 통해 내수성과 내구성을 극대화 하였습니다. 남다른 원칙과 생각으로 뼈대부터 제대로 만들어 습기에 휘거나 부식되지 않고, 시공에 불편함이 없어 실용적입니다.



### 특수 발포 프레임 PVC

- PVC 발포 프레임으로 시공 시 작업이 매우 편리하며 실용성을 극대화
- 구조 보강재**
- 문틀의 기계적 강도 향상을 위한 일체형 Steel-Plate로 보강한 구조
- 태고 합판**
- 뒤틀림 및 휨 방지를 위한 보강목으로 경첩부 나사조임력 유지 및 문짝 반복 개폐 시 내구성 향상

\*예다지 인재를 통하여 정품인지 확인하세요.

FF\_110



FF\_130



FF\_140



FF\_155



FF\_175



FF\_195



FF\_210



FF\_230



FF\_245



**PVC 발포** 미서기 문틀

상하레일을 장착하는 방식으로 설계되어 슬라이딩이 매우 부드럽고, 습기에 강하며 시공이 편리합니다.

SF\_120



PF\_54

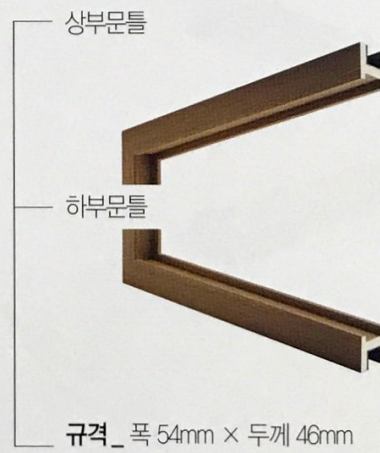

PF\_65



PF\_65 (외출 미서기)



\* 공장상 이색이 있을 수 있습니다.

### 분리형 프레임

분리형 문틀은 문틀과 스톱퍼가 분리되어 있어 시공이 편리하고 다양한 색상 선택이 가능합니다.

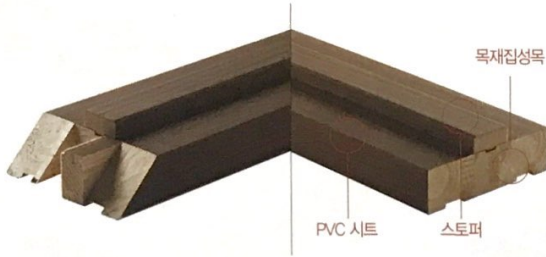

규격\_ 폭 110 / 140 / 170 / 200mm × 두께 40mm

### 일체형 프레임

일체형 프레임은 시공이 간편하고 경제적이며 개폐가 부드럽습니다. 특히 다양한 PVC 시트로 원목의 아름다움을 그대로 재현합니다.

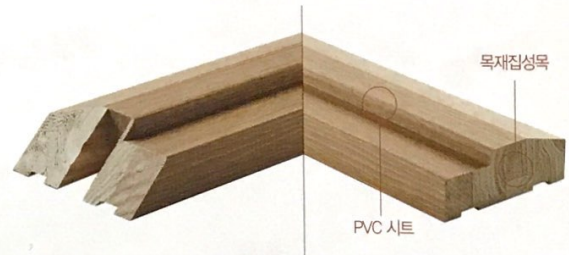

규격\_ 폭 110 / 140 / 170 / 200mm × 두께 40mm

### 목재 미서기(2짝창) 프레임

부드럽게 열리고 닫히도록 제작된 2짝창의 슬라이딩 도어는 횡갈라짐 없이 반영구적인 사용이 가능합니다.



규격\_ 폭 110 / 140 / 170 / 200mm × 두께 40mm

### 가변형 프레임

LVB 가틀 방식으로 시공이 용이하고 하자가 적습니다.

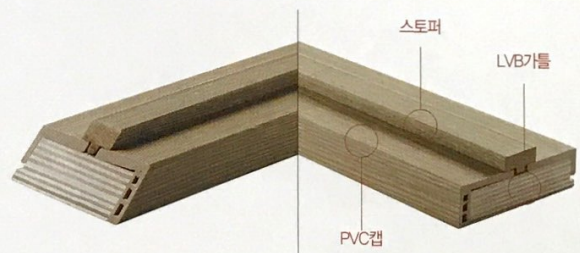

규격\_ 폭 110 / 140 / 170 / 200mm × 두께 40mm

### 매립형 프레임

레일이 들어가는 자리를 미리 가공 후 매립하여 사용  
\*일반 호차 사용 불가 / 높이 조절 호차만 사용 가능

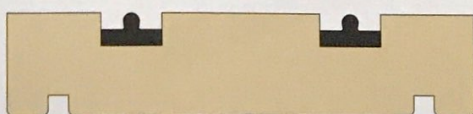
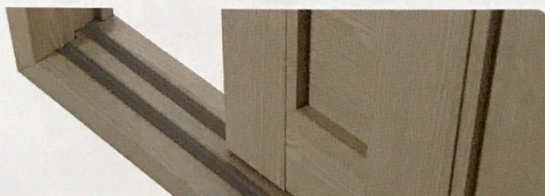

### 일체형 하부레일

2짝 미서기 적용 가능  
하부 문틀 없이 설치 가능하여 공간의 활용을 높였습니다.  
\*일반 호차 사용 불가 / 높이 조절 호차만 사용 가능

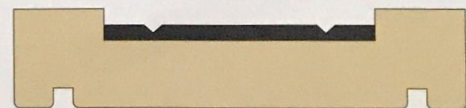
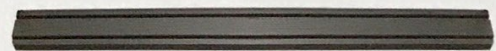

## PVC 가스켓 발포 문틀

소음과 외풍을 막아주어 에너지까지 절약합니다.

### 고무 가스켓 적용

- 문틀에 가스켓을 적용하여 차음효과를 최대화

### 특수 발포 프레임 PVC

- PVC 발포 프레임으로 시공 시 작업이 매우 편리하며 실용성을 극대화

### 구조 보강재

- 문틀의 기계적 강도 향상을 위한 일체형 Steel - Plate로 보강한 구조

### 태고 합판

- 뒤틀림 및 휨 방지를 위한 보강목으로 경첩부 나사조임력 유지 및 문짝 반복 개폐 시 내구성 향상

\*공정상 이색이 있을 수 있습니다.



FF\_110



FF\_130



FF\_140



FF\_155



FF\_175



FF\_195



FF\_210



FF\_230



FF\_245



도어록

**NEW**

YD \_ 100



**NEW**

YD \_ 110  
YD \_ 120  
YD \_ 130



**HIT**

YD \_ 510



**HIT**

YD \_ 410



YD \_ 710N



YD \_ 810B



YD \_ 710B  
[무광]



YD \_ 820B  
YD \_ 910 (향균도어록)



**HIT**

YD \_ 210  
YD \_ 220  
YD \_ 230  
YD \_ 240



YD \_ 310  
YD \_ 320



YD \_ 610K  
YD \_ 610



YD \_ 620K  
YD \_ 620



전자도어락  
[목문용]

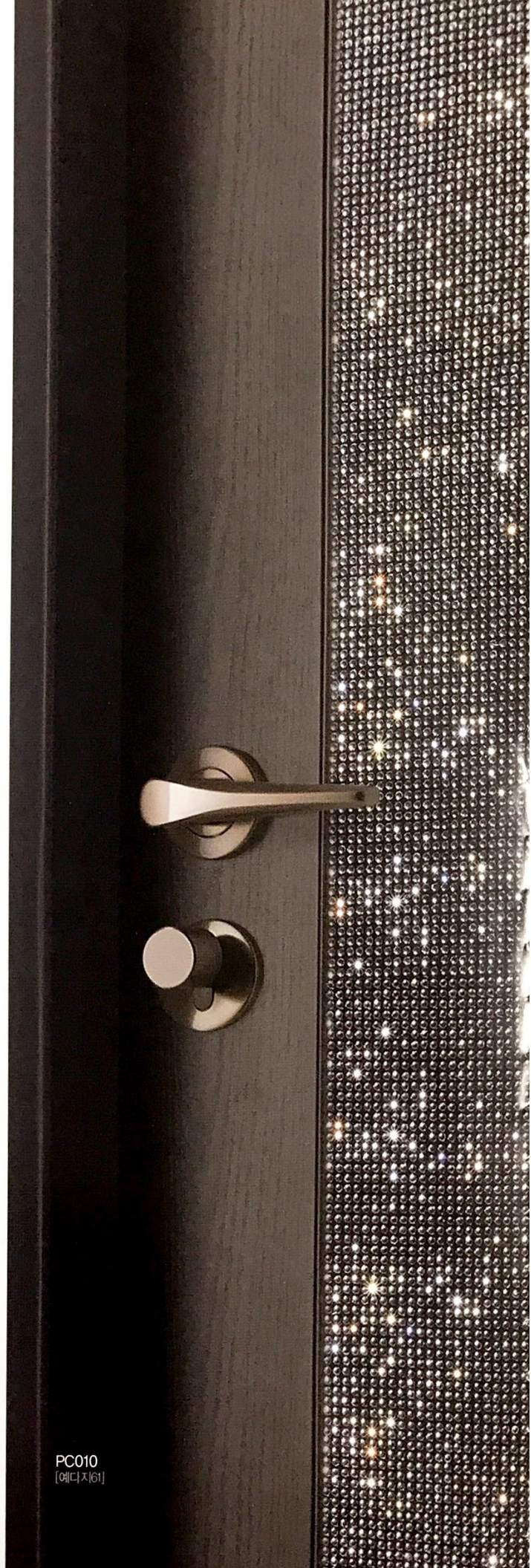

PC010  
[에디지61]

### 모티스

YD\_710[모티스]

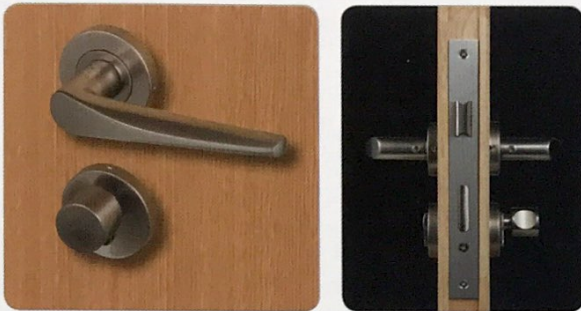

### 인출손잡이

YW\_100



YW\_200



### 손잡이

슬라이딩 락



오목손잡이

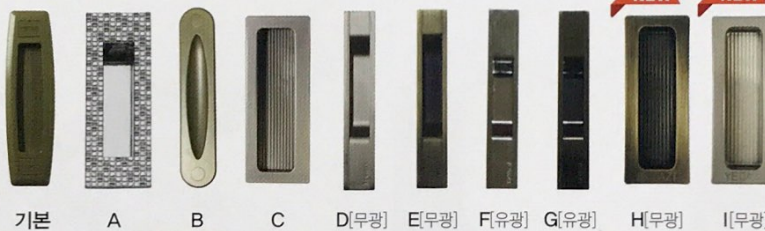

3연동용 손잡이

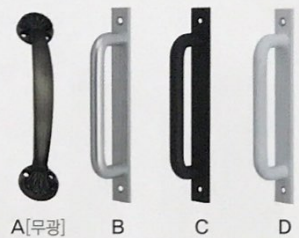

### HINGE 가구 경첩

깔끔하게 물린 경첩이 부드럽게  
도어를 개폐합니다.



가구경첩(110°)  
드레스룸 도어용(댐퍼 별도)

### HINGE 경첩

흔들림 없이 개폐하고, 문의 하중까지 안전하게 지탱합니다.



### 스토퍼



### 도어스토퍼



■도어 무게 : 15~40kg 까지

### 도어클로저 A

NEW

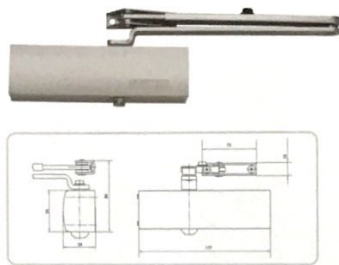

- 허용범위 : 도어폭 1,100m/m까지
- 닫히는 힘 : EN3호(도어폭 950m/m까지)
- 외부경량도어 및 내부 중량도어까지 사용 권장

### 도어클로저 B

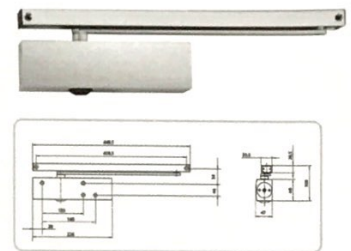

- 허용범위 : 도어폭 1,100m/m까지
- 닫히는 힘 : EN1~4호로 조절 가능
- 내부 중량도어 또는 외부 경량도어 적용 권장

### 무빙 월 시스템

여러 개의 패널을 이용하여 언제든지 필요에 따라 공간을 나누거나 합칠 수 있는 가변형 벽체입니다.

NEW

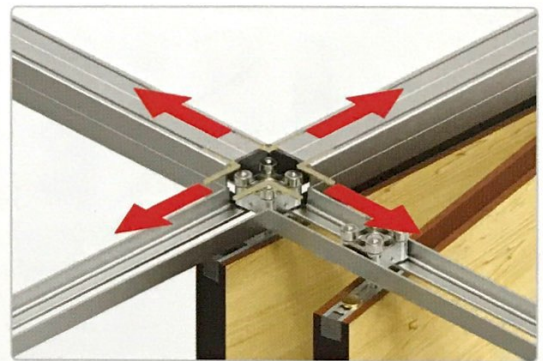
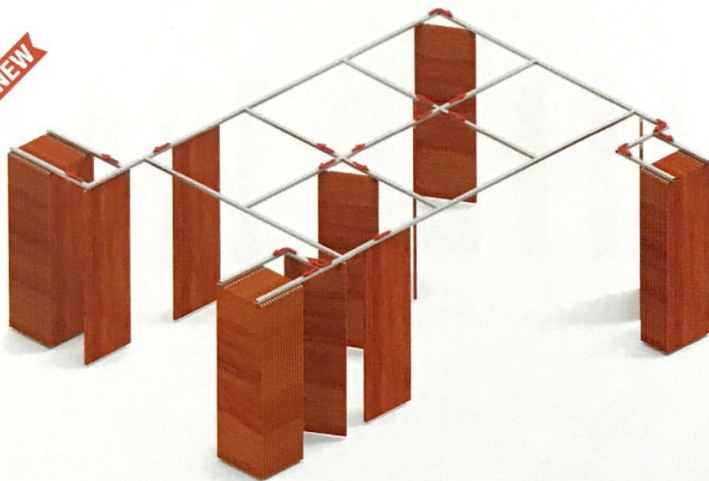

사용 예

F형 결속구조(1)

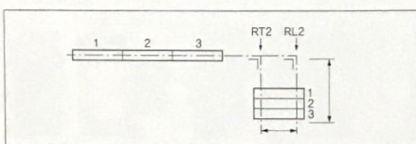

F형 2단 결속구조

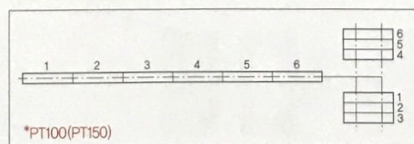

Y형 결속구조(2)

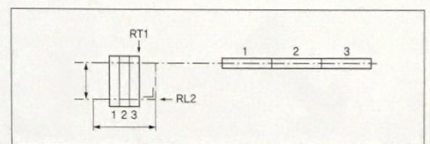

#### L형, T형, X형 결속부품, 연결핀

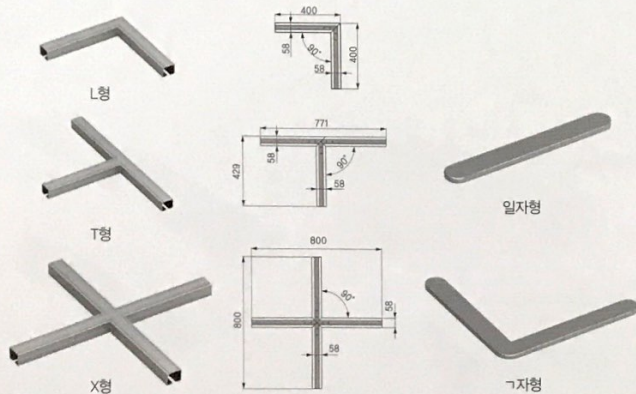

#### 무빙 월 전용 롤러



### ▶ 숲그린 / 조명확인창 ▶

욕실의 습기와 냄새를 배출하는데 도움을 줘 쾌적한 욕실을 만들어줍니다.



**1 조명확인창**  
 - 사이즈 : 29 x 29 mm  
 - 설치가능 도어 두께 : 27 ~ 40mm  
 - 내부 조명 ON / OFF 확인가능



**2 숲그린**  
 - 사이즈 : 23 Ø  
 - 설치가능 도어 두께 : 27 ~ 40mm  
 - 활성탄 페드 내장

### ▶ 대리석 하부도어실 ▶

**NEW**

#### 도어실(문지방)

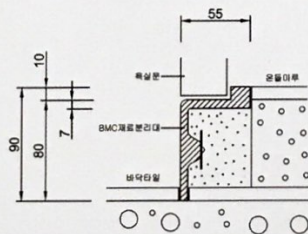

규격 : 55 x 80 x 700~900mm | 52 x 80 x 700~900mm

**NEW**

#### 재료분리대

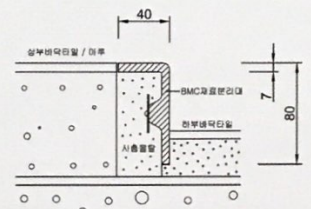

규격 : 40 x 80 x ~1,800mm

**NEW**

#### 마루굽들

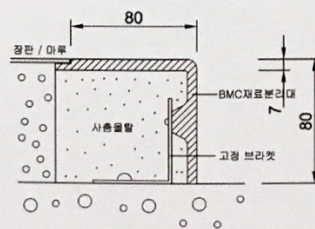

규격 : 80 x 80mm | 150 x 80mm

**NEW**

#### 샤워부스실

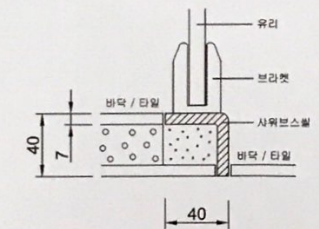

규격 : 40 x 40 x ~1,800mm | 32 x 40 x ~1,800mm

**\*운영컬러**



아티스



골드더스트

\*보이는 이미지와 실제 색상은 차이가 있을 수 있습니다.

# ABS도어 제작가능 사이즈

분류	품명	합지 소		합지 대		비고
		최소	최대	최소	최대	
프리미엄	PA010			360 x 650	1,130 x 2,360	특특대
	PA020			360 x 650	1,130 x 2,360	특특대
	PA030			360 x 650	1,130 x 2,360	특특대
	PE010				1,030 x 2,360	특특대
	PE020				1,030 x 2,360	특특대
	PE030				1,030 x 2,360	특특대
	PG010	680 x 1,870	745 x 2,140		945 x 2,140	
인테리어	NID10	636 x 1,700	745 x 2,055	680 x 1,800	945 x 2,055	
	NID20	636 x 1,900	745 x 2,055	810 x 1,900	945 x 2,055	W : 폴대기준 H : 라벨기준
	NID30	630 x 1,700	745 x 2,055	780 x 1,775	945 x 2,055	
	NID50	420 x 520	745 x 2,055	420 x 520	945 x 2,055	
	NID60	420 x 1,390	745 x 2,055	420 x 1,390	945 x 2,055	
	NID70	640 x 1,500	745 x 2,140	790 x 1,555	945 x 2,140	
	NID80	635 x 1,500	745 x 2,140	680 x 1,500	945 x 2,140	
	NID90	420 x 790	745 x 2,055	420 x 790	945 x 2,055	2,140 특대, 특소 주문재 사용
	NID100	420 x 790	745 x 2,140	420 x 790	945 x 2,140	2,280 특특대, 특특소 주문재 사용
	NID110	420 x 300	945 x 2,055	420 x 300	945 x 2,140	합지 (소) 없음
	NID120	420 x 1,300	945 x 2,055			합지 대
	NID130	400 x 1,720	945 x 2,140			특대합지만
	NID140	650 x 1,800	945 x 2,140			특대합지만
	NID150	680 x 1,100	945 x 2,135			특대합지만
	NID160	450 x 1,100	945 x 2,135			특대합지만
	NID170	590 x 1,400	945 x 2,135			특대합지만
	NID180	650 x 1,800	945 x 2,055			특대합지만
	NID190	400 x 1,500	945 x 2,140			특대합지만
	네이처	RD10	625 x 1,730	745 x 2,055	780 x 1,800	945 x 2,055
RD30		625 x 1,735	745 x 2,055	780 x 1,800	945 x 2,055	2,140 특대, 특소 주문재사용
RD50		630 x 1,710	745 x 2,055	780 x 1,750	945 x 2,055	2,140 특대, 특소 주문재사용
RD60		420 x 790	745 x 2,055	420 x 790	945 x 2,055	2,140 특대, 특소 주문재사용
RD70		450 x 1,600	745 x 2,055	450 x 1,600	945 x 2,055	2,140 특대, 특소 주문재사용
RD90		625 x 1,860	745 x 2,140	780 x 1,860	945 x 2,140	
RD100		628 x 1,805	745 x 2,140	785 x 1,805	945 x 2,140	
RD110		625 x 1,810	745 x 2,140	780 x 1,810	945 x 2,140	
RD120		300 x 300	945 x 2,140			특대합지만
RD130		300 x 300	945 x 2,140			특대합지만
RD140		615 x 1,150	745 x 2,140	750 x 1,150	945 x 2,140	
RD141		615 x 1,150	745 x 2,140	750 x 1,150	945 x 2,140	
RD142		615 x 1,150	745 x 2,140	750 x 1,150	945 x 2,140	
RD143		615 x 1,150	745 x 2,140	750 x 1,150	945 x 2,140	
RD144		615 x 1,150	745 x 2,140	750 x 1,150	945 x 2,140	
RD150		300 x 300	945 x 2,140			특대합지만
RD160		300 x 300	945 x 2,140			특대합지만, 특특대 주문재 사용
RD161		300 x 300	945 x 2,140			특대합지만, 특특대 주문재 사용
RD170		300 x 300	945 x 2,140			특대합지만
RD180		300 x 300	945 x 2,140			특대합지만, 특특대 주문재 사용
RD190		635 x 300	945 x 2,140			
RD200		625 x 1,810	745 x 2,140	780 x 1,810	945 x 2,140	
RD210		300 x 300	945 x 2,140			특대합지만, 특특대 주문재 사용
디럭스	평판				1,030 x 2,360	특특대
	DB10	636 x 1,800	745 x 2,055	800 x 1,800	945 x 2,055	
	DA20	625 x 400	745 x 2,055	780 x 400	945 x 2,055	무늬에 따라 높이 측정
	DA30	625 x 1,500	745 x 2,055	780 x 1,500	945 x 2,055	2,260 특특대 주문재 사용
	RA20	590 x 1,600	745 x 2,055	780 x 1,600	945 x 2,055	
	RA30	620 x 1,710	745 x 2,055	790 x 1,800	945 x 2,055	
	DV10	580 x 1,700	745 x 2,055	580 x 1,700	945 x 2,055	2,260 특특대 주문재 사용
	DV30	630 x 1,820	745 x 2,055	790 x 1,820	945 x 2,055	
	DV50	320 x 1,550	745 x 2,055	320 x 1,550	945 x 2,055	4칸기준 및 라벨 기준 으로 높이측정
	DV70	640 x 1,780	745 x 2,055	790 x 1,865	945 x 2,055	
	DN60	630 x 1,770	745 x 2,055	780 x 1,770	945 x 2,055	2,260 특특대 주문재 사용
	DN70	680 x 1,760	745 x 2,055	800 x 1,760	945 x 2,055	
	DN80	300 x 1,540	745 x 2,140	300 x 1,540	945 x 2,140	2,260 특특대 주문재 사용
	DN90	680 x 1,870	745 x 2,140		945 x 2,140	
	DN100	580 x 300	745 x 2,140	746 x 300	945 x 2,140	무늬에 따라 높이 측정
	DN110	350 x 1,420	945 x 2,140			특대합지만
	DN120	625 x 300	745 x 2,140	746 x 300	945 x 2,140	
	DY10	450 x 300	1,030 x 2,140			특특대가능
	DY20	300 x 600	1,030 x 2,140			특특대가능
	DY30	300 x 1,000	1,030 x 2,140			특특대가능
	DY40	625 x 1,665	825 x 2,140	785 x 1,675	945 x 2,140	도어사이즈에 따라 포인트 위치도 달라짐 포인트 소 : 380 x 1,580 대 : 540 x 1,590
	DY50	400 x 300	1,030 x 2,140			특특대가능 포인트대 : 73 x 73 포인트소 : 53 x 53
	DY60	400 x 750	1,030 x 2,140			특특대가능 포인트 : 110 x 541
	DY70	610 x 1,660	825 x 2,140	734 x 1,660	1,030 x 2,260	포인트 소 : 368 x 1,572 대 : 490 x 1,572 NC작업
	DY100	500 x 500	1,030 x 2,260			다대 150 넘김, 타공 최소 높이 400
	DY110	450 x 1,500	945 x 2,135			손잡이 위치

\*DY 모델 2,360까지 가능

## 시공시 유의사항 및 A/S 규정

### 공통사항

- 본 카다록에 사용된 이미지 및 제품은 이해를 돕기 위한 연출된 이미지이므로 형태 및 색상 등이 실제와 다를 수 있습니다. 제품 구입 시 예다지 시트샘플북으로 색상을 확인해 주십시오.
- 동절기 보호랩 제거 시 상온 15도 이상에서 작업하시기 바랍니다. 해당 온도 이하일 때는 헤어 드라이어를 사용하여 천천히 제거 작업을 하셔야 본드 남김 현상을 줄일 수 있습니다.
- 예다지의 제품들은 디자인 보호법 제 84조에 의거하여 무단 복제 및 상업적 도용 시 형사처벌을 받을 수 있습니다.
- 이동 및 적재 중에 발생한 스크래치, 핀홀, 타카자국, 시트지 터짐 등에 의해서 발생한 작은 하자는 연성 메꿈재를 통해 해결할 수 있습니다.
- 제품에 표시된 사이즈는 약간의 오차가 있을수 있습니다.

### 도어 & 프레임

- 무거운 문(타공도어, 알판도어, 유리도어 등)을 여닫이로 설치할 경우 문짝 처짐을 방지하기 위하여 이지 경첩보다는 일반 경첩을 사용하십시오.
- 화장실과 같이 습기가 많은 장소, 다용도실과 같이 안과 밖의 온도차가 심한 장소의 경우 발포 문틀 및 ABS 도어 제품으로 시공을 권장합니다.
- 발포문틀/목문틀 설치 시 앙카로 벽면을 견고히 고정하십시오.  
미 고정 시 우레탄폼 미장 등에 의해 문틀이 변형 또는 도어 걸림현상이 발생할 수 있습니다.
- 발포문틀 식기무(無)의 경우 하부쪽 좁아짐 현상이 발생할 수 있으므로 시공 시 상·하 치수 확인이 필요합니다.
- ABS 도어는 직사광선에 노출 시 도어에 변형이 생길 수 있습니다. 이동이나 적재 시 직사광선을 피해 보관하시고 직사광선에 의한 휨 현상이 있을 시 설치 전 앞·뒷면을 교체하시면 복원될 수 있습니다.
- ABS 도어는 열합지 공정으로 인해 엇지, 문틀, 몰딩 등의 색상과 차이가 발생합니다.(이색현상은 시트지 색상불량이 아님을 알려드립니다.)

### 연동도어

- 문짝 시공 후 휨 현상이 생길 경우 문짝을 해체 후 앞·뒷면을 교체해 재설치 하시면 문짝간 걸림현상을 해결하실 수 있습니다.
- 문틀 시공 후 빠른 시일 내에 문짝에 유리 및 단조설치를 완료하시기 바랍니다. 입구창 도어 특성상 변형이 단기간에 진행될 수 있습니다.
- 연동도어용 유리디자인은 도어규격과 커팅되는 면적에 따라 카다록과 차이가 있을 수 있습니다.

### 몰딩

- MDF 몰딩은 온도차에 의해 수축 팽창이 일어날 수 있습니다.
- 목공용 본드나 글루건을 이용하여 절단면을 접착해 주시고, 실측 사이즈보다 1~2mm가량 길게 재단하여 시공하여 수축현상을 줄일 수 있습니다.
- 래핑 천정 몰딩 시공 시 천정면과 벽면에 맞닿은 부분을 목공용 본드로 접착 후 타카로 고정합니다.

### A/S 규정

- 무상 보증기간은 자사 제조불량에 한하여 구입일로부터 1년 이내이며 추가 발생하는 모든 A/S는 유상처리됩니다.
- A/S기간 이후(1년 경과) 접수시 실비(제조비용, 출장비 등)가 청구될 수 있음을 알려드립니다.
- 단, 자사 제조불량 외 설치부주의(문틀 앙카 미고정, 경첩 오설치 등)에 의한 A/S는 1년 미만일 경우에도 실비가 청구됨을 알려드립니다. 소모성 부품(연동호차, 모헤어 등)에 관해서는 당사에서 구매가 가능합니다.

### 사용상 주의사항

- 제품 성능을 위해서 반드시 표준 시방을 준수하여 시공해 주십시오.
- 문을 열려두지 마십시오. 바람에 의해 갑자기 닫혀 손가락이 끼거나 유리가 깨질 수 있습니다.
- 유리가 깨질 수 있으니, 문에 기대거나 힘껏 밀지 마십시오.
- 문을 여닫을 때 손이 끼지 않도록 주의하십시오.
- 떨어지거나 넘어져 다칠 수 있으니, 문이나 손잡이에 매달리지 마십시오.
- 문틀(하부문턱)에 걸려 넘어질 수 있으니, 주의하십시오.
- 난방기구의 열풍이나 열기가 문에 직접 닿지 않게 하십시오. 변형이나 화재의 원인이 됩니다.
- 출입문 이외의 용도로 사용하지 마십시오.(예 : 유아용 그네, 액자 설치 등)
- 당사 제품은 실내용이므로 실외에서 사용하지 마십시오.

각종 설치 및 시공관련 자료는 예다지 홈페이지([www.yedazidoor.com](http://www.yedazidoor.com))를 참조하세요.