



A DAS-023 [P] (엠보에스라인)
 C SUN-108 P 크리스탈
 H HLP-S03

※ 상기 이미지는 이해를 돕기 위한 이미지입니다.
 ※ 제품이미지와 색상의 차이가 있을 수 있으므로 샘플북을 참조바랍니다.

ABS DOOR

선우드의 무늬결을 살린 성형으로
 변하지 않는 아름다움을 디자인하다

습기에 의한 뒤틀림이나 변형이 없고 내구성이 탁월하며
 소재가 가벼워 시공의 편리성이 뛰어납니다.

A ABS도어 M 멤브레인 도어 C Color P Point G Glass H Hardware



A DAS-023 [P] (엠보에스라인) C SUN-163 P 크리스탈 H HLP-S03
 A DAS-023 (엠보에스라인) C SUN-149 H HLP-S03

최소 495×1,100 최대 933×2,060 ※크리스탈 포인트는 옵션사항입니다.
 ※고퀄리티 크리스탈포인트를 적용하시면 럭셔리한 공간연출이 가능합니다.

www.우주건축자재.com

뛰어난 내구성 도어에 감각적인 포인트를 더하다
 습기에 강하여 변형이 없는 ABS도어는 주거용, 상업용으로 인기가 좋습니다.



A DAS-003 M DMA-B01 C SUN-010 H HLP-A04

최소 400×700 최대 950×2,060

※ 멤브레인 도어는 음각없이 라인으로만 표현됩니다.



A DAS-003[P] M DMA-B01[P] C SUN-010 H HLP-A04



P PON-A01-1



P PON-A01



A DAS-020 (씨클) C SUN-101 H HLP-H06

최소 533×960 최대 950×2,060



A DAS-020[P] (씨클) C SUN-101 H HLP-H06



P PON-A02 (원)

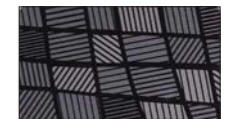

P PON-A02-1 (원-1)



A DAS-021 (오로라) C SUN-007 H HLP-S03

최소 533×960 최대 950×2,060



A DAS-021[P] (오로라) C SUN-007 H HLP-S03



P PON-A03 (꽃잎)

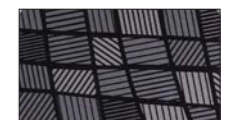

P PON-A03-1 (꽃잎-1)



A DAS-006 M DMT-007
 C SUN-152 H HLP-A01
 최소 615 최대 950×2,060



A DAS-007 M DMT-006
 C SUN-101 H HLP-A01
 최소 356×660 최대 950×2,060

※ 크리스탈 포인트는 옵션사항입니다.
 ※ 고품질 크리스탈포인트를 적용하시면 럭셔리한 공간연출이 가능합니다.



적용모델
 DAS-006, 007



적용모델
 DAS-005, 008, 009, 010



A DAS-M01 C SUN-141 P SUN-E03 H HLP-H04

PS몰딩 P125-1



A DAS-M01 C SUN-007 P SUN-E02 H HLP-A04

PS몰딩 114-6



A DAS-005 M DMT-004
 C SUN-007 H HLP-S02
 최소 230×800 최대 950×2,060



A DAS-008 M DMT-008
 C SUN-179 H HLP-H04
 최소 380×860 최대 950×2,060



A DAS-009 M DMT-009
 C SUN-110 H HLP-H03
 최소 356 최대 950×2,060



A DAS-010 M DMT-010
 C SUN-007 H HLP-S03
 최소 435 최대 950×2,060



A DAS-M01 C SUN-146 P SUN-153 H HLP-H05

PS몰딩 114-6



A DAS-M02 C SUN-151 P SUN-B04 H HLP-A04

PS몰딩 D225-4





A DAS-025 (아망페)
 C SUN-010
 H HLP-H05
 최소 660×1,735
 최대 933×2,060



A DAS-025 (아망페)
 C SUN-165
 H HLP-H05
 최소 660×1,735
 최대 933×2,060



A DAS-026 (엘레나)
 C SUN-002
 H HLP-H04
 최소 660×1,735
 최대 933×2,060



A DAS-026 (엘레나)
 C SUN-168
 H HLP-H04
 최소 660×1,735
 최대 933×2,060



A DAS-001 C SUN-141 H HLP-S03
 최소 620×1,210 최대 950×2,060

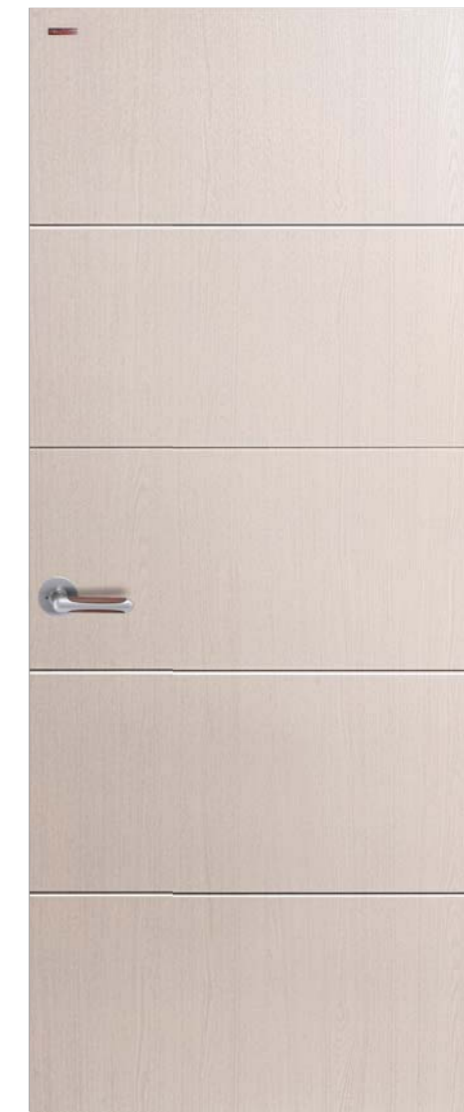

A DAS-002 M DMA-003 C SUN-108 H HLP-A03
 최소 350 최대 950×2,060



A DAS-004 M DMA-B02 C SUN-148 H HLP-A04
 최소 635×1,650 최대 950×2,060

모던한 디자인에 실용성을 더하다
 모던한 디자인이라 어떠한 공간에서도 잘 어울립니다.

www.우주건축자재.com



A DAS-012 C SUN-171 H HLP-H02
 최소 340 최대 950×2,060

HIT



A DAS-013 C SUN-B07 H HLP-H03
 최소 635×1,079 최대 950×2,060



A DAS-014 C SUN-117 H HLP-H01
 최소 230×1,120 최대 950×2,060



A DAS-100 M DLA-001
 C SUN-142 H HLP-H03



A DAS-100 M DLA-001
 C SUN-150 H HLP-H01



A DAS-S01 C SUN-010 H HLP-S03
 최소 475×1,060 최대 950×2,060

HIT



A DAS-016 M DMA-015
 C SUN-141 H HLP-A04
 최소 400×1,340 최대 950×2,060



A DAS-018 (비플라이)
 C SUN-146 H HLP-A04
 최소 533×1,520 최대 950×2,060



A DAS-019 (머리언)
 C SUN-149 H HLP-S03
 최소 533×1,520 최대 950×2,060



A DAS-S02 C SUN-134 H HLP-S03
 최소 450×1,520 최대 950×2,060



A DAS-S03 C SUN-110 H HLP-S03
 최소 525×1,450 최대 950×2,060



A DAS-S04 C SUN-141 H HLP-S03
 최소 425×1,080 최대 950×2,060

※ 멤브레인 도어는 음각없이 라인으로만 표현됩니다.



A DAS-L01 M DLA-S07
C SUN-101 H HLP-S02



A DAS-L02 M DLA-S08
C SUN-173 H HLP-A03



A DAS-L03 M DLA-S06
C SUN-002 H HLP-A02

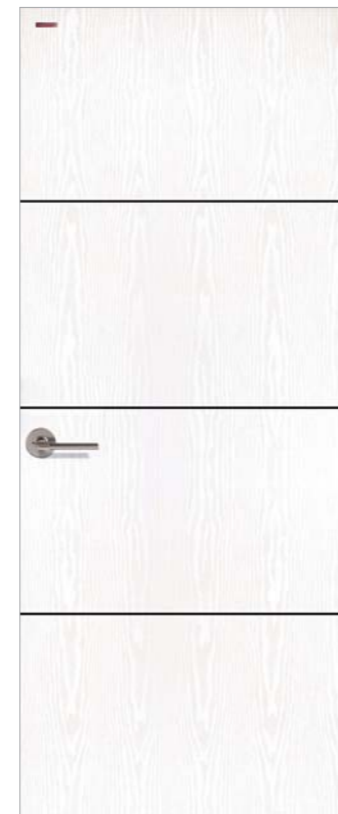

A DAS-L04 M DLA-S02
C SUN-007 H HLP-S02



A DAS-L09 M DLA-S09
C SUN-174 H HLP-H01

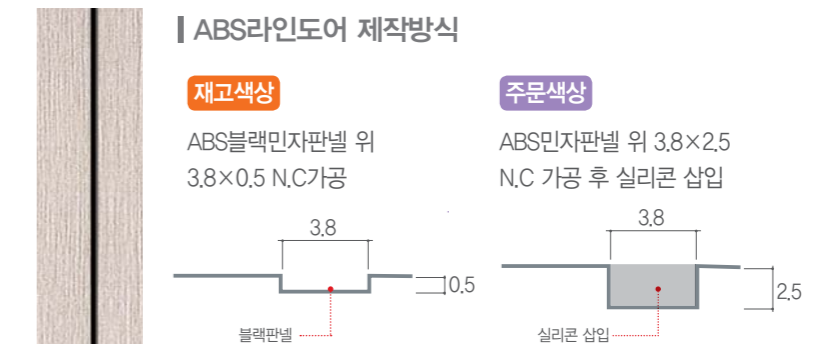

A DAS-L05 M DLA-S01
C SUN-149 H HLP-H06



A DAS-L06 M DLA-S03
C SUN-010 H HLP-A03



A DAS-L07 M DLA-S04
C SUN-134 H HLP-H06

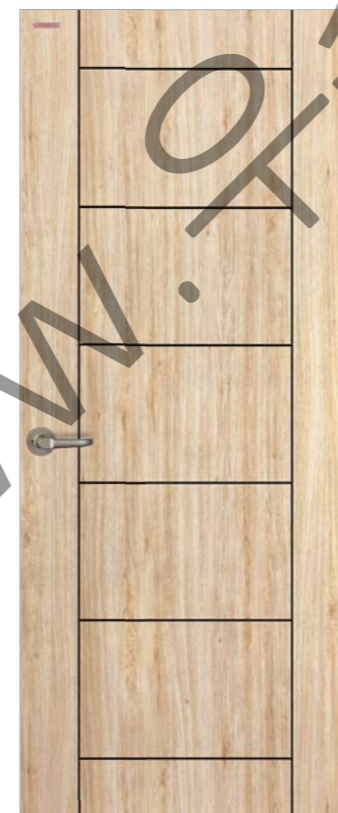

A DAS-L08 M DLA-S05
C SUN-147 H HLP-H06



A DAS-L10 M DLA-S10
C SUN-010 H HLP-H01



A DAS-L11 M DLA-S11
C SUN-008 H HLP-S03



A DAS-L12 M DLA-S12
C SUN-007 H HLP-S03

※ 재고색상만 제작가능

※ DAS-L13~L16 도어는 블랙라인과 회색라인으로 옵션 선택이 가능합니다.
 ※ 주문형 시트는 회색라인입니다. (재고시트만 블랙라인이 가능합니다.)

※ 제품이미지와 색상의 차이가 있을 수 있으므로 샘플북을 참조바랍니다.
 ※ 무늬목 제품 특성상 제품별 패턴 컬러가 상이 할 수 있습니다.
 ※ 문틀, 문선 색상은 도어와 차이날 수 있습니다.

A ABS도어 M 멤브레인 도어 C Color P Point G Glass H Hardware

NEW



A DAS-L13
 C SUN-149
 P 크리스탈
 H HLP-H01



NEW



A DAS-L14
 C SUN-151
 P 크리스탈
 H HLP-H03



NEW



A DAS-L15
 C SUN-008
 H HLP-H03



NEW



A DAS-L16
 C SUN-110
 H HLP-H01



프리미엄 ABS 무늬목 도어

원목 무늬결의 자연스러움과 ABS의 방수성을 결합한 프리미엄 도어

NEW



A DVS-001 C 오크무늬목 + 월넛무늬목(포인트) H HLP-H03
 ※ 문틀, 문선, 엣지 선택은 시트북을 참조바랍니다.(관찰시트 : SUN-109)

최대 1030×2,180

NEW



A DVS-002 C 오크무늬목 H HLP-H03



HIT

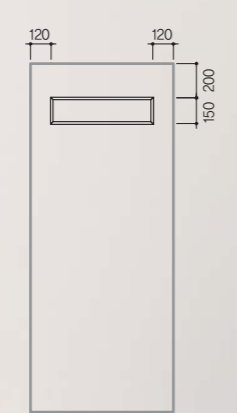

- A DAS-P09
- M DLP-013
- C SUN-164
- G 워터큐브 (5mm)
- H HLP-S03

ABS DOOR GLASS

※ 제품이미지와 색상의 차이가 있을 수 있으므로 샘플북을 참조바랍니다.
 ※ 선우드의 다양한 유리선택이 가능합니다 (P100~103 참조)
 A ABS도어 M 멤브레인 도어 C Color P Point G Glass H Hardware

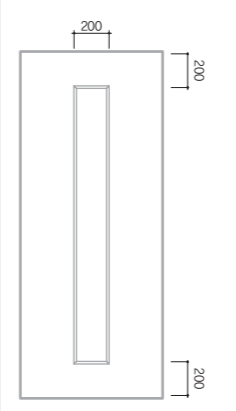

- A DAS-P01
- M DLP-001
- C SUN-007
- H HLP-S03

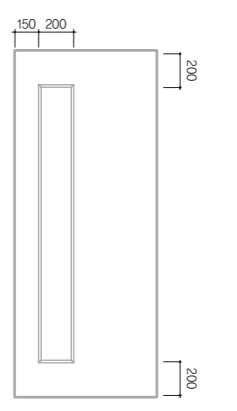

- A DAS-P02
- M DLP-002
- C SUN-110
- H HLP-S03

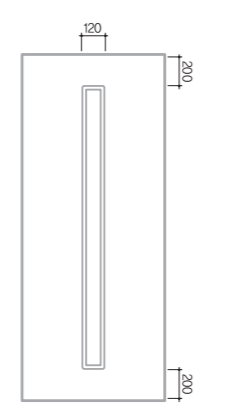

- A DAS-P07
- M DLP-011
- C SUN-134
- G 미스트유리 (5mm)
- H HLP-H01



HIT

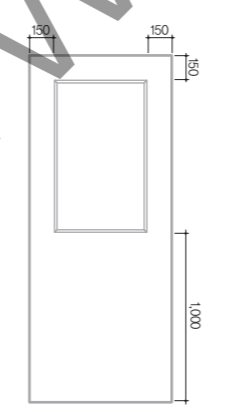

- A DAS-P08
- M DLP-012
- C SUN-154
- G 망입유리 (7mm)
- H HLP-H01

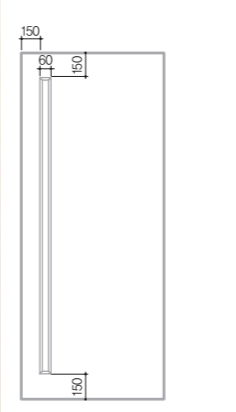

- A DAS-P04
- M DLP-005
- C SUN-141
- G 브론즈유리 (5mm)
- H HLP-H06

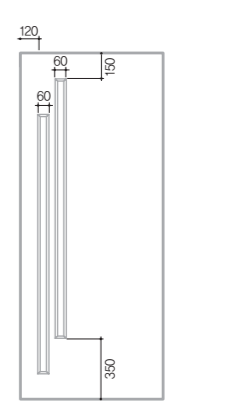

- A DAS-P05
- M DLP-007
- C SUN-008
- G 브론즈유리 (5mm)
- H HLP-S03

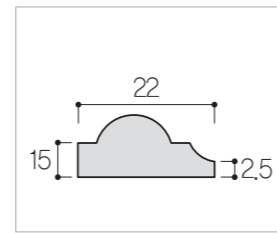

DAS-P11, P12 하부 비드타입

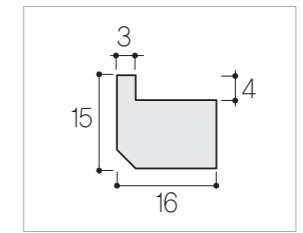

DAS-P13 하부 비드타입

NEW



A DAS-P11 M DLP-015
 C SUN-170 G 클리어라인(5mm) H HLP-H04

NEW



A DAS-P12 M DLP-016
 C SUN-170 G 클리어라인(5mm) H HLP-H01

NEW



A DAS-P10 M DLP-014
 C SUN-134 G 다이아유리(5mm) H HLP-H05

NEW



A DAS-P13 M DLP-017
 C SUN-167 G 고풍유리(5mm) H HLP-H02

심플 디자인에 스페셜 스타일을 더하다
 심플함과 특별함, 그리고 화려함을 살려 더욱 아름답습니다



M DMT-012 C SUN-150 P 크리스탈 H HLP-H06



M DMT-013 C SUN-147 P 크리스탈 H HLP-H06



M DMK-005 C SUN-168 H HLP-H04
 ※ 정교한 표면가공으로 질감이 살아있습니다.
 ※ 주문생산 제품입니다.

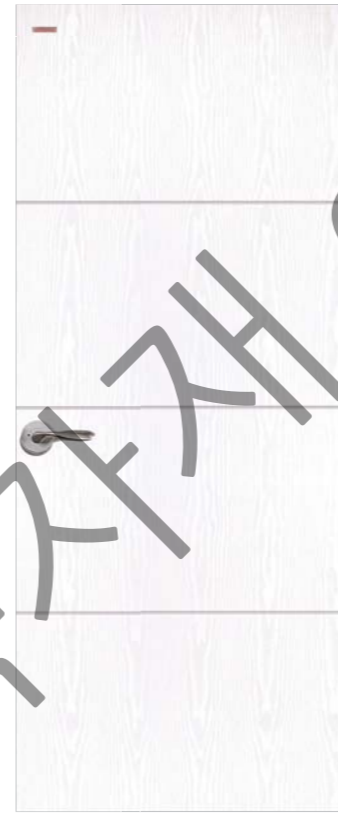

M DMA-002 C SUN-007 H HLP-S03



M DMA-003 A DAS-002 C SUN-108 H HLP-A01



M DMA-004 C SUN-134 H HLP-A01



M DMA-005 C SUN-110 H HLP-S03



M DMA-006 C SUN-175 H HLP-H06



M DMA-007 C SUN-172 H HLP-H06



M DMA-026 C SUN-167 H HLP-H02



M DMA-027 C SUN-168 H HLP-H03

MEMBRANE DOOR

※ 제품이미지와 색상의 차이가 있을 수 있으므로 샘플북을 참조바랍니다.
 A ABS도어 M 멤브레인 도어 C Color P Point G Glass H Hardware



M DMB-S01 C SUN-110 P SUN-P05 H HLP-S03

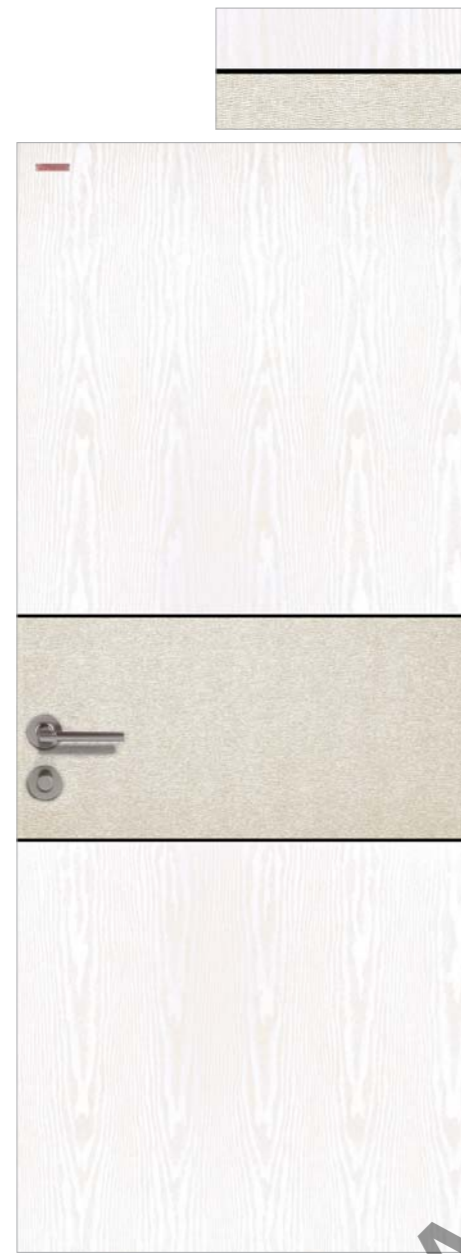

M DMB-S05 C SUN-007 P SUN-P01 H HLM-S02



M DMB-S07 C SUN-010 P SUN-P04 H HLM-S02

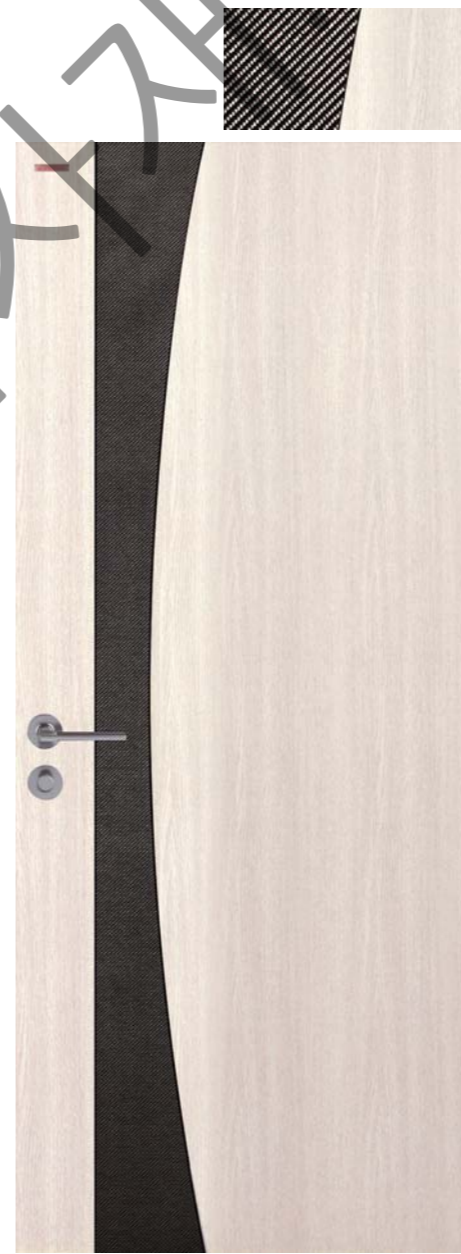

M DMB-S12 C SUN-108 P SUN-P05 H HLM-S02



M DMB-S13 C SUN-134 P SUN-155 H HLP-H03



M DMA-022 C SUN-010 P 알루미늄 포인트 H HLP-H01



BEAD PANEL

모던과 클래식을 동시에 담다
 몰딩처리로 모던하면서도 심플한 도어로
 클래식한 분위기가 돋보입니다.

A ABS도어 M 멤브레인 도어 C Color P Point G Glass H Hardware

※비드알판포인트도어는 비드를 제외한 디자인으로 제작가능합니다.



M DLE-001
 P 사진 (V-Line)
 C SUN-164
 H HLP-S03

※ 상기 이미지는 이해를 돕기 위한
 이미지컷입니다.

※ 제품이미지와 색상의 차이가
 있을 수 있으므로 샘플북을
 참조바랍니다.

클래식과 섬세함이 완벽한 하모니를 이룬다
 클래식하면서도 정교한 몰딩처리로 아름다운 조화를 이룹니다.

모던함과 단아함이 환상적인 조화를 이룬다
 현대적인 감각과 트렌드를 살려 멋진 공간연출이 돋보입니다.



M DLE-001 P 그물(Net) C SUN-168 H HLP-A05



M DLE-001 P 모자이크 C SUN-166 H HLP-A06



M DLE-001 P 내추럴 C SUN-167 H HLP-A06



M DLE-001(G) P PS몰딩 370(GOLD)
 C SUN-143 H HLP-A05



M DLE-001(S) P PS몰딩 370(SILVER)
 C SUN-143 H HLP-A06

BEAD PANEL

※ 제품이미지와 색상의 차이가 있을 수 있으므로 샘플북을 참조바랍니다.
 A ABS도어 M 멤브레인 도어 C Color P Point G Glass H Hardware



M DLE-003 C SUN-008 H HLP-H04



M DLE-002 C SUN-177 H HLP-H04



M DLE-001 C SUN-147 H HLP-H06



M DLE-001 C SUN-146
P PON-J03 H HLP-A04



M DLE-002 C SUN-134
P PON-J03 H HLP-A04



M DLE-001 C SUN-136
P PON-J05 H HLP-S03



M DLE-002 C SUN-010
P PON-J05 H HLP-S03



M DLE-001 C SUN-007
P PON-J01 H HLP-A01



M DLE-002 C SUN-142
P PON-J01 H HLP-A01



M DLE-001 C SUN-110
P PON-J06 H HLP-S03



M DLE-002 C SUN-101
P PON-J06 H HLP-S03

DOWN DOOR

살아있는 입체감을 느끼다

심플하고 모던한 도어로 표면에 포인트의 입체감이 생생하게 살아있습니다.

A ABS도어 M 멤브레인 도어 C Color P Point G Glass H Hardware



M DLC-G03
C SUN-117
P PON-G03
H HLP-S03



www.이집트자재.com

※ 상기 이미지는 이해를 돕기 위한 이미지컷입니다.
※ 제품이미지와 색상의 차이가 있을 수 있으므로 샘플북을 참조바랍니다.

심플함과 모던한 감각이 돋보인다

표면의 단차와 포인트 감각이 더해져 현대적인 예술미가 살아납니다.



M DLC-002 C SUN-171 H HLP-H01



M DLC-003 C SUN-169 H HLP-S03



M DLC-E02 C SUN-179 P SUN-B13(엠보:웨이브) H HLP-H01

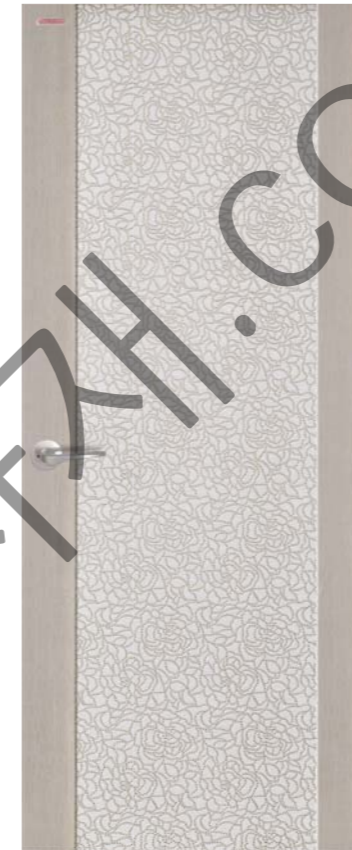

M DLC-G01
C SUN-008
P PON-G01
H HLP-A01

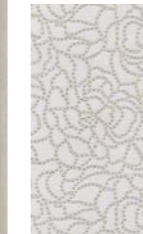

M DLC-G01
C SUN-010
P PON-G04
H HLP-A01



M DLC-G02
C SUN-002
P PON-G02
H HLP-H06



M DLC-G02
C SUN-007
P PON-G03
H HLP-H06

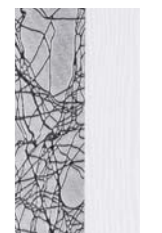



INTERIOR DOOR

※ 상기 이미지는 이해를 돕기 위한 이미지컷입니다.
 ※ 제품이미지와 색상의 차이가 있을 수 있으므로 샘플북을 참조하십시오.

INTERIOR DOOR 낙엽송 자작

※ 제품이미지와 색상의 차이가 있을 수 있으므로 샘플북을 참조하십시오.
 ※ 주문생산 제품으로 시공환경에 따라 제작 가능합니다.
 ※ 제품 특성상 나무결 및 웅이 등에 따라 제품별 이미지가 상이할 수 있습니다
 A ABS도어 M 멤브레인 도어 C Color P Point G Glass H Hardware

자연의 아름다움이 숨쉬는 인테리어 도어
 무늬결이 살아있어 상업공간, 주거공간등의 인테리어 도어로 멋스러움이 돋보입니다.

NEW



M DLC-L07 (여닫이) P 낙엽송 (투명도장)
 C SUN-155 H HLP-H01

NEW



M DLC-L07 (행거) P 낙엽송 (투명도장)
 C SUN-155 H HPH-001(B)

NEW



M DLA-B01 (자작도어) H HLP-H03
 ※ 문선과 문틀은 샘플북에서 선택하시기 바랍니다.

THE DOOR

GLASS DOOR

FRAME & HARDWARE

MOULDINGS

FUNCTIONALITY

WALL FINISHING

FLOORING

ARTWALL

KOREAN LATTICE DOOR

한국 고유의 전통미가 살아있다

한옥의 고전미가 느껴지는 고풍스러운 도어로
은은하고 기품있는 아름다움이 느껴집니다.

A ABS도어 M 멤브레인 도어 C Color P Point G Glass H Hardware



M DWP-C07 (격자살)
C SUN-141
H HLP-S03

www.우주건축자재.com



전통살 문양을 그대로 살려 은은함이 흐르다
 한국의 전통적인 문양을 살려 은은한 멋이 살아 숨칩니다.

전통살 도어 살문 방식 [유리제작시]



M DWP-C04 (띠살) C SUN-009 H HLP-H04



M DWP-C05 (정자살A) C SUN-141 H HLP-H04



M DWP-C06 (정자살B) C SUN-141 H HLP-H04



M DWP-C01 (아자살) C SUN-008 H HLP-S03



M DWP-C02 (돌림살) C SUN-010 H HLP-S03



M DWP-C03 (팔각돌림살) C SUN-004 H HLP-S03

GALLERY DOOR

갤러리의 럭셔리한
품격이 느껴지다

갤러리에서 느끼는 품격과 분위기를
그대로 느낄 수 있습니다.



A DAS-G01 M DLA-G01
C SUN-007 H HLP-A04

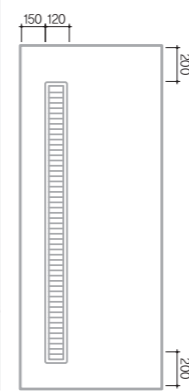

A DAS-G02 M DLA-G02
C SUN-010 H HLP-A01



M DWG-004 (에어컨갤러리1)
C SUN-141 H HLP-A01



M DWG-005 (에어컨갤러리2)
C SUN-010 H HLP-A01



M DWG-006 (막힌갤러리)
C SUN-008



M DWG-001 C SUN-145 H HLP-A01



M DWG-002 C SUN-162 H HLP-S03



M DWG-003 C SUN-166 H HLP-S03



스킨도어1



스킨도어2

SKIN DOOR

나무의 흠과 결이
그대로 살아나다

원목의 스킨에서 느끼는
자연스러운 터치가
그대로 느껴집니다.

KIDS DOOR

내 아이의 안전을 지켜주는 도어
사랑하는 아이의 안전을 지켜줍니다.

A ABS도어 M 멤브레인 도어 C Color P Point G Glass H Hardware



안전도어
안전성 인증



선우드 손끼임 방지 안전도어 시스템

문틀과 도어 사이에 설치하여 문이 열리고 닫힐때
경첩 부분에 손끼임을 방지하는 제품입니다.
어린이 안전사고 예방 및 개정된 건축법에 맞춘
신개념 안전 장치입니다.

※ 손끼임 방지 안전도어 시스템을 결합하여 사용하시면 더 안전합니다.
※ 자세한 사항은 P.120를 참조바랍니다.

업계최초 안전도어 인증  선우드 도어 프레임
KS인증 업체



www.우주건축자재.com

※ 상기 이미지는 이해를 돕기 위한 이미지컷입니다.
※ 제품이미지와 색상의 차이가 있을 수 있으므로 샘플북을 참조바랍니다.

파스텔 컬러로 아이들의 꿈을 키우다
 다양한 파스텔톤으로 아이들의 꿈과 희망을 키워줍니다.

동심의 세계에서 자녀의 표정이 밝아지다
 자연을 늘 가까이 만나 자녀의 인성교육에도 좋습니다.



M DMF-008 (마루나) C SUN-156 P SUN-157 H HLP-H01



M DMF-007 (푸르니) C SUN-121 P SUN-162 H HLP-H01

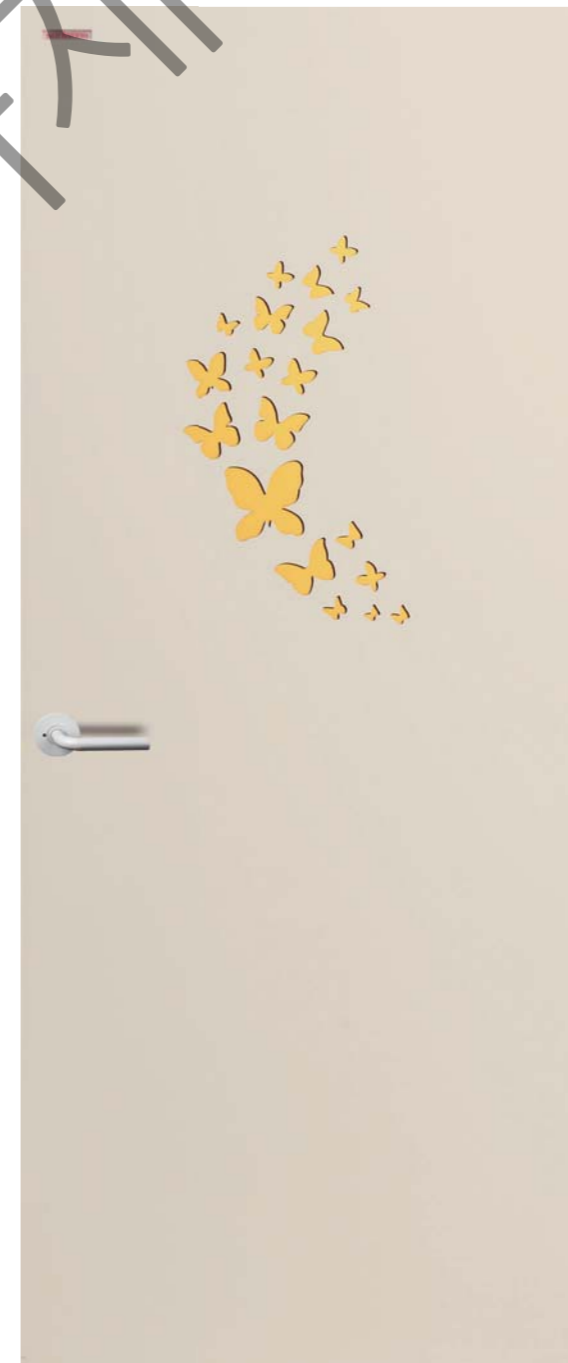

M DMF-006 (나래울) C SUN-168 P SUN-120 H HLP-H02



M DMF-005 (미리별) C SUN-166 P SUN-117 H HLP-H02

GLASS DOOR

공간의 예술적 가치를 더하다
유리와 문을 결합시켜 안과 밖이 하나되어
예술적인 공간가치가 높아집니다.

A ABS도어 M 멤브레인 도어 C Color P Point G Glass H Hardware

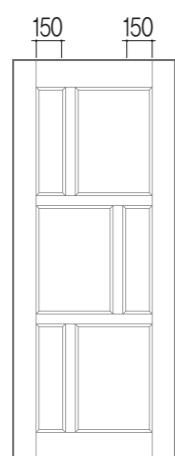

M DWP-W11(6구대소)
C SUN-110
G 워터큐브(대), 고방(소)
H HLP-S03



www.우산건축자재.com

※ 상기 이미지는 이해를 돕기 위한 이미지컷입니다.
※ 제품이미지와 색상의 차이가 있을 수 있으므로 샘플북을 참조바랍니다.

※ 제품이미지와 색상의 차이가 있을 수 있으므로 샘플북을 참조바랍니다.
 ※ 선우드의 다양한 유리선택이 가능합니다 (P100~103 참조)
 A ABS도어 M 멤브레인 도어 C Color P Point G Glass H Hardware

도어내부와 외부에 예술감이 느껴지다
 도어에 자연을 담아 모던하고 고급스런 공간연출이 가능합니다.



M DWP-W09 (7구1칸고시) C SUN-138 H HLP-A01



M DWP-W10 (10구) C SUN-110 H HLP-H05



M DWP-W12 (1칸고시 살문) C SUN-146
 G 아쿠아유리 (5mm) H HLP-A01



M DWP-W01 (5구) C SUN-008 H HLP-S03



M DWP-W02 (4구) C SUN-002 H HLP-H06

[DWP-W12 살문 제작방식 [유리제작시]

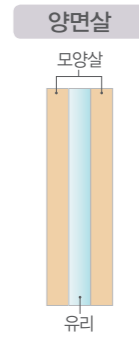

www.우주건축자재.com

GLASS DOOR

※ 제품이미지와 색상의 차이가 있을 수 있으므로 샘플북을 참조바랍니다.
 ※ 선우드의 다양한 유리선택이 가능합니다 (P100~103 참조)
 A ABS도어 M 멤브레인 도어 C Color P Point G Glass H Hardware



M DWP-W05(3구2칸고시) C SUN-008 H HLP-S03



M DWP-W06 (2구) C SUN-101 H HLP-S03



M DWP-W07 (2구1칸고시) C SUN-010
 G 망입유리 (7mm) H HLP-H03



M DWP-W08 (1/4고시) C SUN-122
 H HLP-H04 ※ 비드색상 옵션



M DWP-003 C SUN-141 H HLP-H05



M DWP-W08 (1/4고시) C SUN-163
 H HLP-H01 ※ 비드색상 옵션



M DWP-W12 C SUN-166 G 망입유리 (7mm) H HLP-H04



INTERLOCK DOOR

공간과 사람을 하나로 이어준다
 공간과 공간, 사람과 사람을 하나로 이어주는
 도어로 공간가치를 넓혀드립니다.

A ABS도어 M 멤브레인 도어 C Color P Point G Glass H Hardware

- * 오목 손잡이는 옵션사항입니다. (적용타입 : 민자다대)
- * 연동도어에는 다양한 유리의 선택이 가능합니다.



M DWP W12
 C SUN-166
 G 망입유리(7mm)

* 상기 이미지는 이해를 돕기 위한 이미지컷입니다.
 * 제품이미지와 색상의 차이가 있을 수 있으므로 샘플북을 참조바랍니다.

INTERLOCK DOOR

※ 오목 손잡이는 옵션사항입니다.
 ※ 실제품은 투명유리로 제작됩니다.
 ※ 상기이미지는 이해를 돕기위한 이미지컷입니다.
 ※ 제품이미지와 색상의 차이가 있을 수 있으므로 샘플북을 참조바랍니다.

2연동, 3연동 도어로
 좁은 공간도 더 넓게 -

독립성과 쾌적성, 그리고
 에너지절약 효과까지 더한
 기능성 도어입니다.



M DWP-W08 C SUN-166 G 망입유리(7mm) H HDR-002
 ※ 비드색상 옵션

망입유리 (패브릭, 우레탄)



일반 (6.2T)
 유리(3mm)
 메탈사+접합필름(0.2mm)
 유리(3mm)
 강화 (6.2T)
 유리(3mm)
 메탈사+접합필름(0.2mm)
 유리(3mm)



G 골드패브릭 C SUN-002



일반 (6.2T)
 유리(3mm)
 메탈사+접합필름(0.2mm)
 유리(3mm)
 강화 (6.2T)
 유리(3mm)
 메탈사+접합필름(0.2mm)
 유리(3mm)

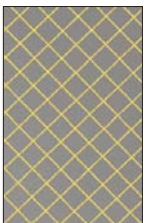

G 로얄골드 C SUN-010



M DWP-003 C SUN-008 G 나뭇잎(5mm) H HDR-002
 ※ 포켓집 가람판은 별도입니다.



M DWP-W08 C SUN-008 G 망입미스트(7mm) H HDR-002



G 로얄실버 C SUN-164

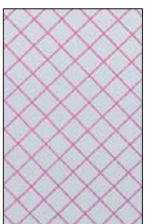

G 로얄퍼플 C SUN-007

INTERLOCK DOOR

※ 오목 손잡이는 옵션사항입니다.
 ※ 실제품은 투명유리로 제작됩니다.
 ※ 상기이미지는 이해를 돕기위한 이미지컷입니다.
 ※ 제품이미지와 색상의 차이가 있을 수 있으므로 샘플북을 참조하십시오.

인쇄유리

일반 (16T)	강화 (14T)
유리(4mm)	유리(3mm)
간층(8mm)	간층(8mm)
유리(4mm)	유리(3mm)



G GUP-318 (오리엔탈)
C SUN-002

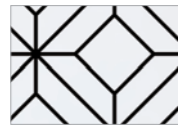

G GUP-319 (리스)
C SUN-147



G GUP-321 (블라썸)
C SUN-007



G GUP-301 (워터플라워)
C SUN-169



G GUP-303 (매화)
C SUN-007



G GUP-305 (접시꽃)
C SUN-147



NEW



G GUP-322 (크랙)
C SUN-164



HIT



G GUP-311 (망입인쇄) C SUN-164

일반 (8.5T)	강화 (6.5T)
유리(4mm)	유리(3mm)
침함필름(0.5mm)	침함필름(0.5mm)
유리(4mm)	유리(3mm)

망입안전필름 침함유리(주문색상으로 생산가능)
 망입디자인 안전필름 침함유리 제품으로 색상이 다양하고 파손시 충격물이 유리를 관통하지 않으며 파편이 비산되지 않아 강화유리나 기존의 망입유리보다 더 안전한 제품입니다.

망입유리 (화이트)	망입유리 (다크블랙)
망입유리 (레드와인)	망입유리 (블루시안)

HIT



G GUP-306 (수선화)
C SUN-002



G GUP-310 (나비)
C SUN-010



G GUP-312 (매직)
C SUN-164



INTERLOCK DOOR

※ 오목 손잡이는 옵션사항입니다.
 ※ 실제품은 투명유리로 제작됩니다.
 ※ 상기이미지는 이해를 돕기위한 이미지컷입니다.
 ※ 제품이미지와 색상의 차이가 있을 수 있으므로 샘플북을 참조하십시오.

펄 + 인쇄유리

일반 (16T)	강화 (14T)
유리(4mm)	유리(3mm)
간봉(8mm)	간봉(8mm)
유리(4mm)	유리(3mm)



G GUP-317 (꽃바람)
C SUN-169



G GUR-001 (사이니)
C SUN-164

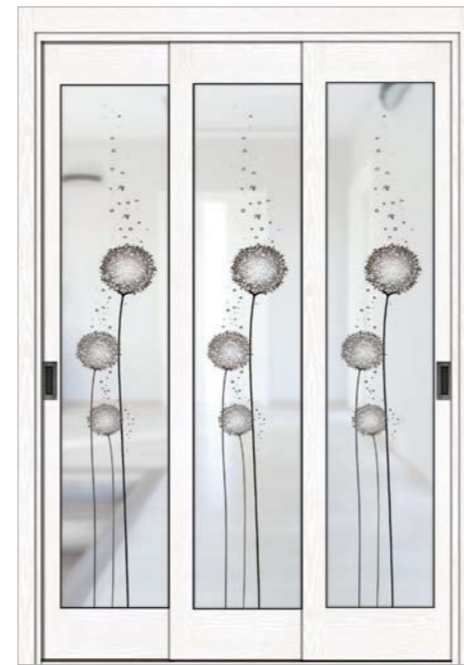

G GUR-002 (민들레)
C SUN-007

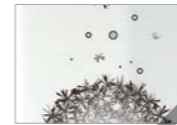

NEW



G GUR-007 (에일린)
C SUN-010



NEW

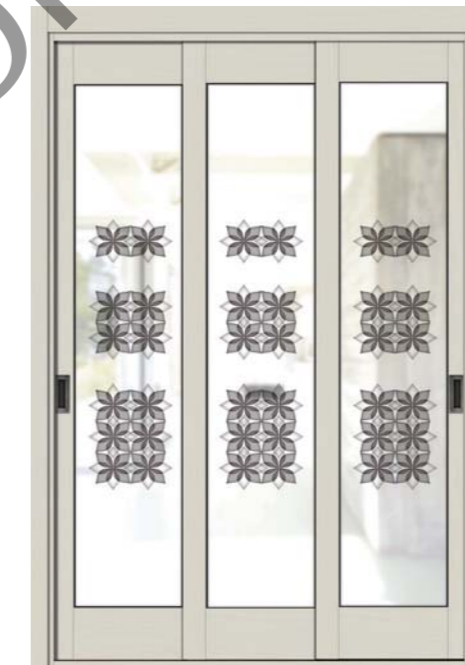

G GUR-008 (벨라)
C SUN-169



보석+인쇄유리

일반 (16T)	강화 (14T)
유리(4mm)	유리(3mm)
간봉(8mm)	간봉(8mm)
유리(4mm)	유리(3mm)



G GUC-001 (트윙글)
C SUN-007



G GUR-003 (꽃나리)
C SUN-010



G GUR-005 (에블린)
C SUN-147



G GUR-006 (멜로디)
C SUN-002



G GUC-002 (엘리사)
C SUN-002

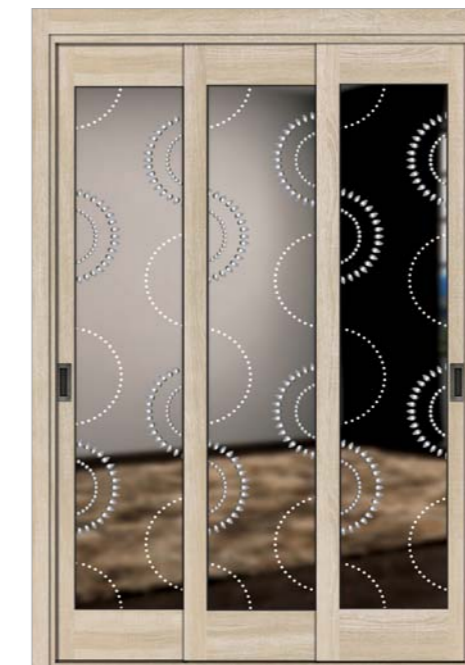

G GUC-003 (리젠트)
C SUN-010



NEW



G GUC-004 (심플라인)
C SUN-007

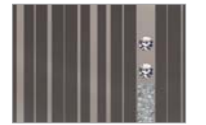

INTERLOCK DOOR

※ 오목 손잡이는 옵션사항입니다.
 ※ 실제품은 투명유리로 제작됩니다.
 ※ 상기이미지는 이해를 돕기위한 이미지컷입니다.
 ※ 제품이미지와 색상의 차이가 있을 수 있으므로 샘플북을 참조바랍니다.

NEW

큐빅인쇄유리

일반 (12.5T)	강화 (10.5T)
유리(4mm) 간봉(4.5mm) 유리(4mm)	유리(3mm) 간봉(4.5mm) 유리(3mm)



G GUB-001 (아모스)
C SUN-007

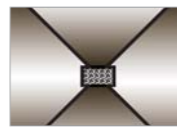

G GUB-002 (러스크)
C SUN-164



G GUB-003 (로이스)
C SUN-169



보석유리

일반 (16T)	강화 (14T)
유리(4mm) 간봉(8mm) 유리(4mm)	유리(3mm) 간봉(8mm) 유리(3mm)

HIT

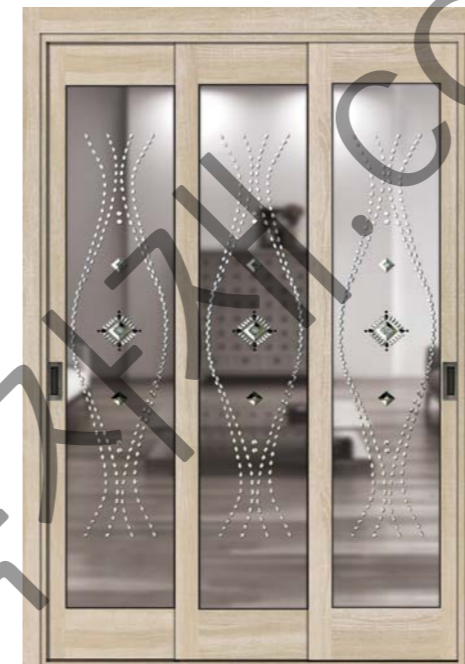

G GCC-009 (제노아)
C SUN-010

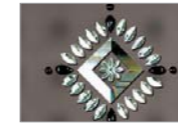

G GCC-010 (스타일)
C SUN-164

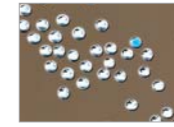

G GCC-012 (등백꽃)
C SUN-007



스마트 커팅+보석유리

일반 (16T)	강화 (14T)
유리(4mm) 간봉(8mm) 유리(4mm)	유리(3mm) 간봉(8mm) 유리(3mm)



G GCA-001 (패턴)
C SUN-164



G GCA-002 (별무리)
C SUN-147

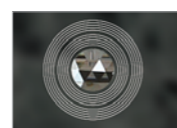

G GCA-003 (은하수)
C SUN-169



NEW

데코스타+보석

일반 (16T)	강화 (14T)
유리(4mm) 간봉(8mm) 유리(4mm)	유리(3mm) 간봉(8mm) 유리(3mm)



G GCC-014 (자벨)
C SUN-002

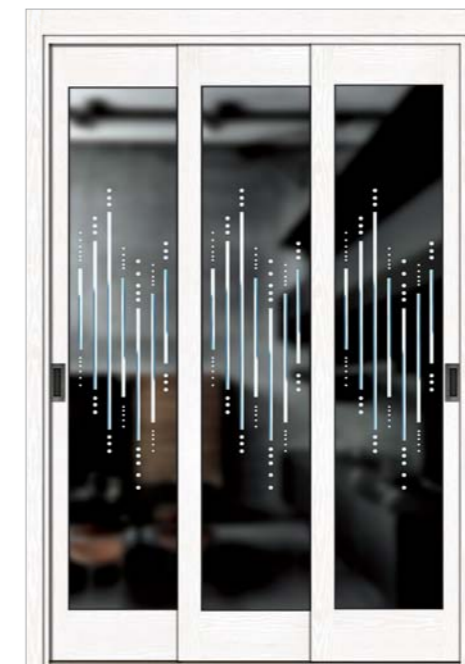

G GCD-001 (미라클)
C SUN-007

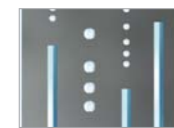

G GCD-002 (로제타)
C SUN-147



INTERLOCK DOOR

※ 오목 손잡이는 옵션사항입니다.
 ※ 실제품은 투명유리로 제작됩니다.
 ※ 상기이미지는 이해를 돕기위한 이미지컷입니다.
 ※ 제품이미지와 색상의 차이가 있을 수 있으므로 샘플북을 참조하십시오.

NEW

포인트 접합



G GLR-001 (비체)
 C SUN-010

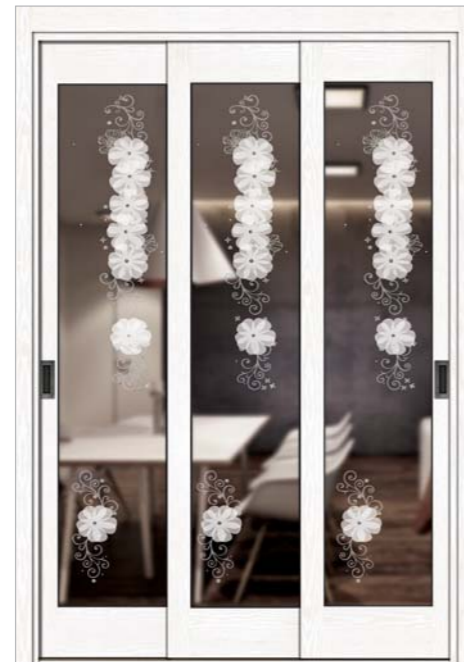
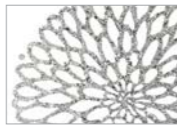

G GLR-002 (엘라)
 C SUN-007



보석단조유리

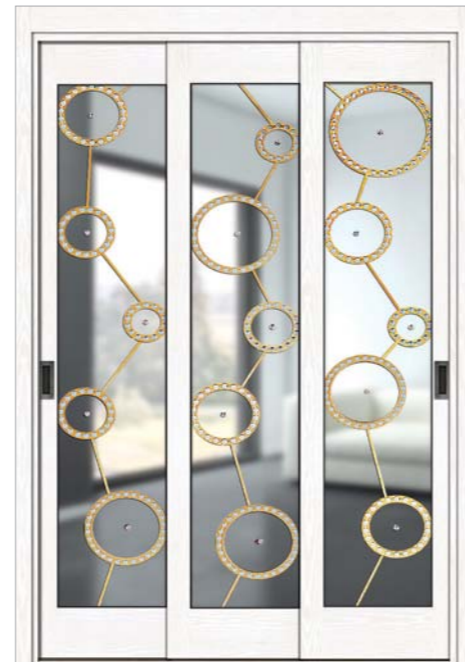

G GDC-601 (저글링)
 C SUN-007



큐빅단조



G GDB-001 (플랫)
 C SUN-007



G GDB-002 (로페즈)
 C SUN-010



NEW



G GDB-003(베르디)
 C SUN-164



G GDC-602 (고목나무)
 C SUN-002



G GDC-304 (뉴트럴)
 C SUN-164



NEW

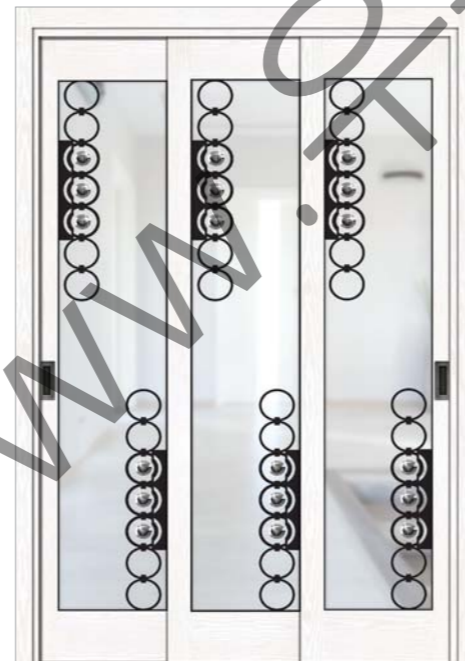

G GDC-305 (루시아)
 C SUN-007



단조

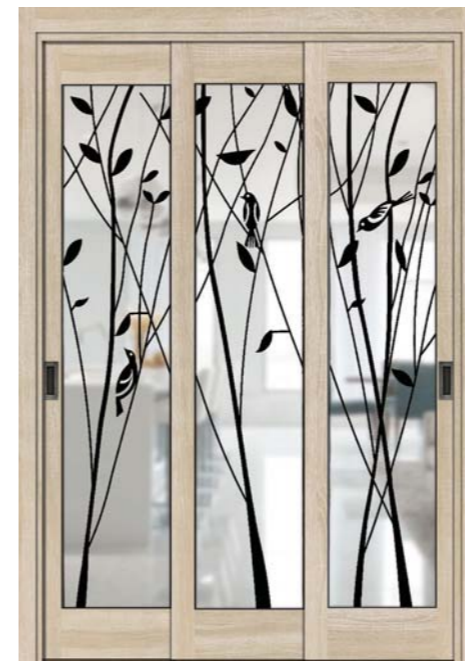

G GDG-301 (새벽)
 C SUN-010



G GDG-302 (꽃나비)
 C SUN-007

HIT



G GDG-303 (자작나무)
 C SUN-147

INTERLOCK DOOR

※ 오목 손잡이는 옵션사항입니다.
 ※ 실제품은 투명유리로 제작됩니다.
 ※ 상기이미지는 이해를 돕기위한 이미지컷입니다.
 ※ 제품이미지와 색상의 차이가 있을 수 있으므로 샘플북을 참조하십시오.

HIT



GDG-304 (너도밤나무) SUN-002

HIT



GDG-309 (빙쿨) SUN-164

HIT



GDG-316 (아누스) SUN-007



GDG-317 (파랑새) SUN-164



GDG-310 (베이지) SUN-169



GDG-312 (바로크) SUN-002



GDG-318 (가로등) SUN-147



GDG-319 (담쟁이) SUN-010

INTERLOCK DOOR

※ 오목 손잡이는 옵션사항입니다.
 ※ 실제품은 투명유리로 제작됩니다.
 ※ 상기이미지는 이해를 돕기위한 이미지컷입니다.
 ※ 제품이미지와 색상의 차이가 있을 수 있으므로 샘플북을 참조바랍니다.

HIT



G GDG-320 (나팔꽃) C SUN-002



G GDG-321 (산책) C SUN-147

투톤단조

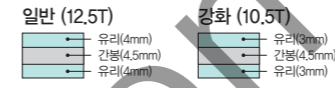

NEW



G GDT-314 (로망) C SUN-002

NEW



G GDT-315 (베이스) C SUN-147



G GDG-322 (사각) C SUN-007



G GDG-323 (비트윈) C SUN-010



G GDT-311 (라피노) C SUN-002



G GDT-312 (루미에) C SUN-164

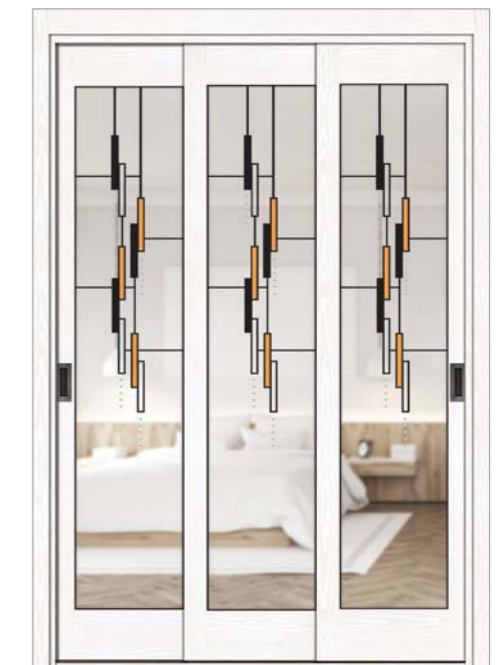

G GDT-313 (포인트) C SUN-007

INTERLOCK DOOR

※ 오목 손잡이는 옵션사항입니다.
 ※ 실제품은 투명유리로 제작됩니다.
 ※ 상기이미지는 이해를 돕기위한 이미지컷입니다.
 ※ 제품이미지와 색상의 차이가 있을 수 있으므로 샘플북을 참조바랍니다.

NEW

한지단조

일반 (12.5T)		강화 (10.5T)	
유리(4mm)	간격(4.5mm)	유리(3mm)	간격(4.5mm)
유리(4mm)	유리(4mm)	유리(3mm)	유리(3mm)



GDT-603 (커스텀) SUN-002



GDT-607 (부메랑) SUN-007



GDH-001 (들꽃) SUN-147



GDH-002 (난초) SUN-002



GDT-608 (골든듀) SUN-010



GDT-609 (크로스) SUN-147

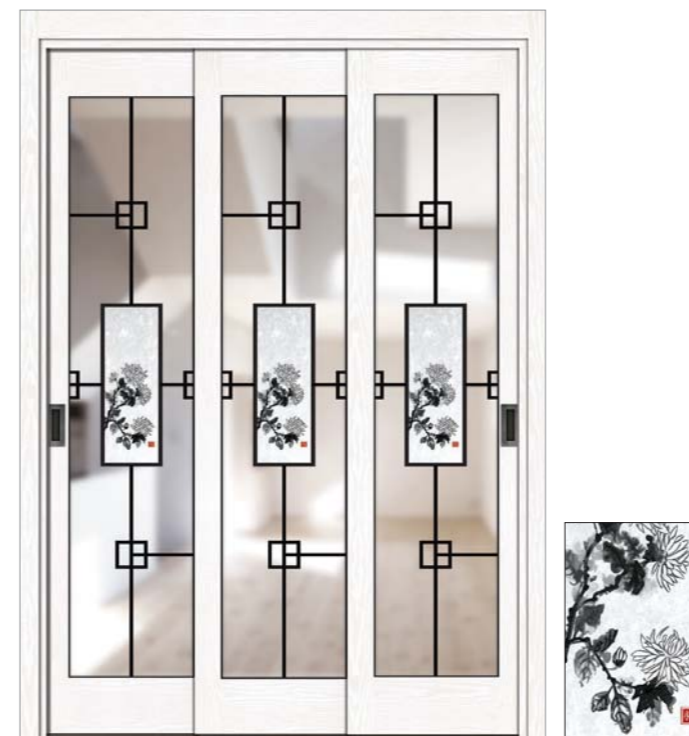

GDH-003 (국화) SUN-007



GDH-004 (대나무) SUN-010

INTERLOCK DOOR

※ 오목 손잡이는 옵션사항입니다.
 ※ 실제품은 투명유리로 제작됩니다.
 ※ 상기이미지는 이해를 돕기위한 이미지컷입니다.
 ※ 제품이미지와 색상의 차이가 있을 수 있으므로 샘플북을 참조바랍니다.

NEW

베벨드단조

일반 (12.5T)

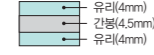

강화 (10.5T)

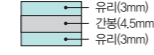

G GVD-001 (엠버)
 C SUN-164



G GVD-002 (제이드)
 C SUN-002

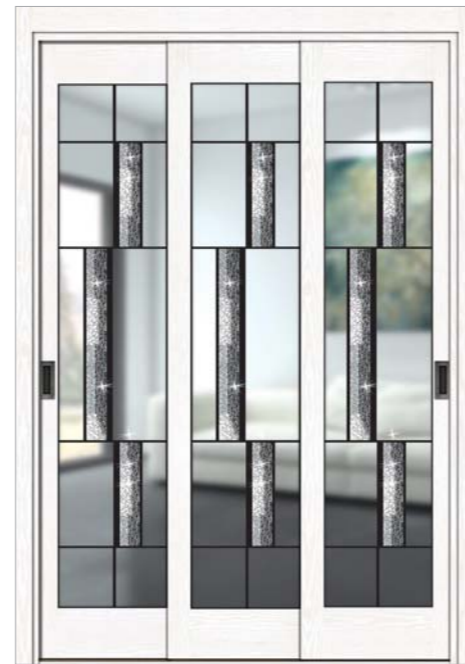

G GVD-003 (헤이즐)
 C SUN-007



베벨드유리



G GVG-001 (유네스코)
 C SUN-164



G GVG-002 (실크로드)
 C SUN-002



일반 (16T)

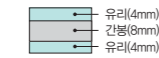

강화 (14T)

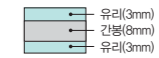

G GVD-004 (그레이스)
 C SUN-147



G GVD-005 (페이지)
 C SUN-169



일반 (18T)

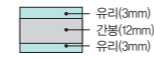

G GVG-003 (로코코)
 C SUN-007

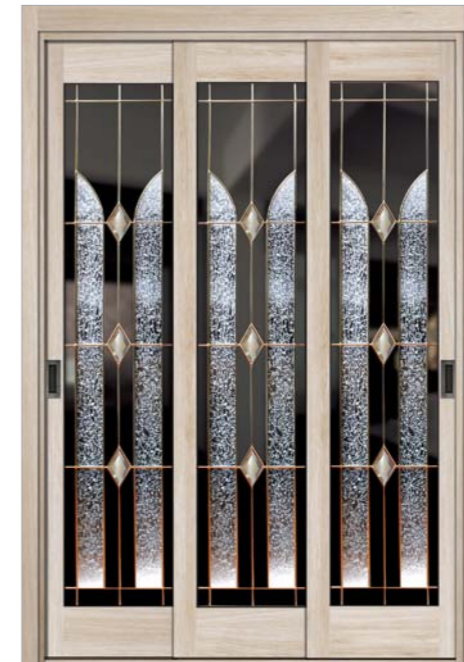

G GVG-004 (세인트)
 C SUN-147



G GVG-005 (비อนด์)
 C SUN-169



INTERLOCK DOOR

※ 실제품은 투명유리로 제작됩니다.
 ※ 상기이미지는 이해를 돕기위한 이미지컷입니다.
 ※ 제품이미지와 색상의 차이가 있을 수 있으므로 샘플북을 참조하십시오.

자연미에 부드러운 패턴을 살리다

생생하게 살아움직이는 식물의 패턴을 살려 생동감이 느껴집니다.

단조색상칩 (※ 인쇄된 색상은 실제 색상과 다를 수 있습니다.)



GDG-002



GDG-003



GDG-004



GDG-005

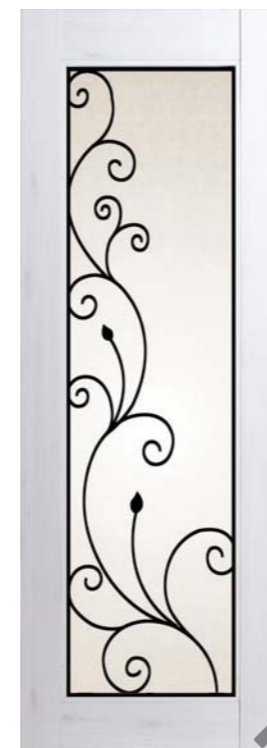

GDG-006

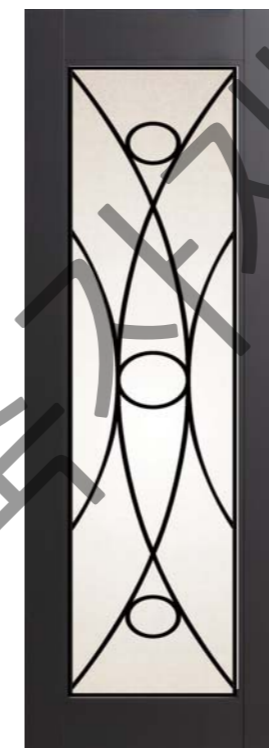

GDG-600

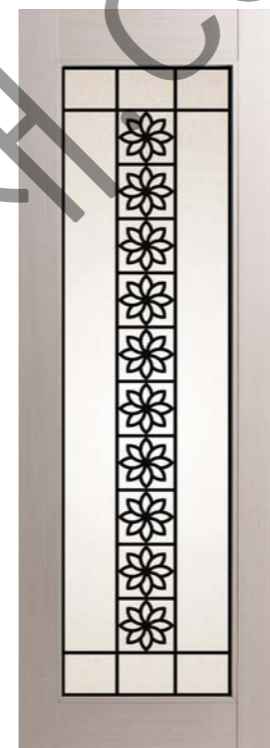

GDG-607

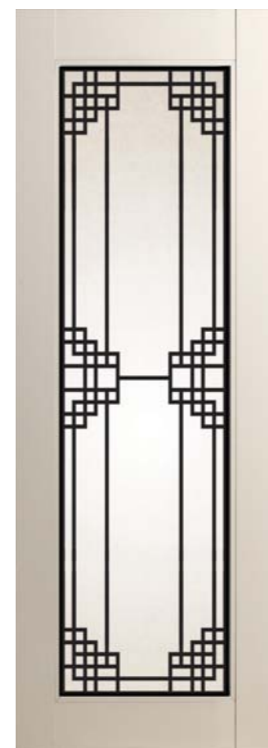

GDG-611



GDG-613



GDG-628



GDG-008



GDG-011



GDG-013



GDG-411



GDG-413



GDG-618



GDG-619



GDG-621



GDT-603



GDG-018



글라스 도어 유리투명도



투명 (5mm)



미스트 (5mm)

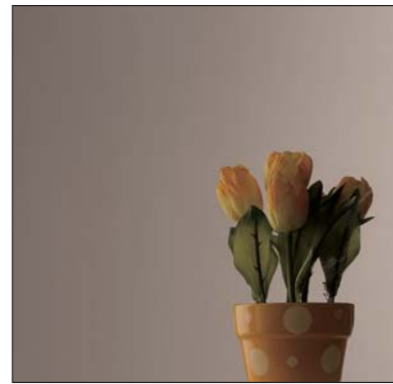

브론즈 (5mm)



그린 (5mm)



SG-P01 (5mm)



SG-P02 (5mm)

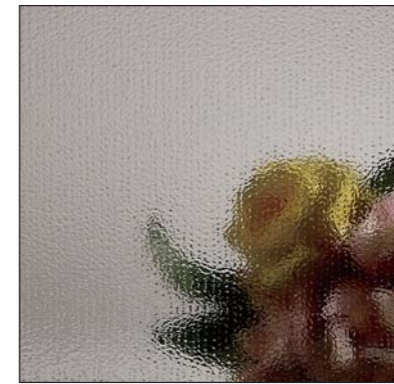

SG-P03 (5mm)



SG-P04 (5mm)



망임미스트 (7mm)



망임 (7mm)



다이아 (5mm)



워터큐브 (5mm)



SG-P05 (5mm)

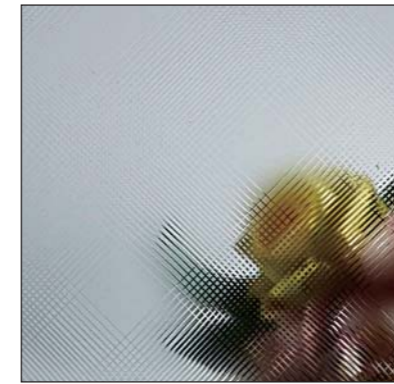

SG-P06 (5mm)

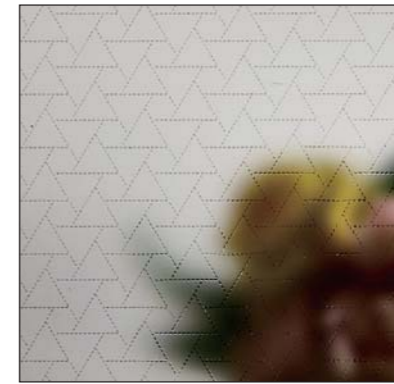

SG-P07 (5mm)



SG-C01 (5mm)



고방 (5mm)



나뭇잎 (5mm)



아쿠아 (5mm)



모루 (5mm)

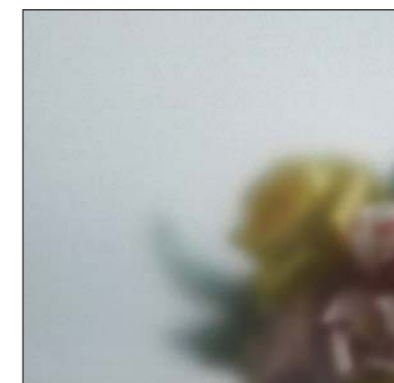

SG-C02 (5mm)



SG-C03 (5mm)

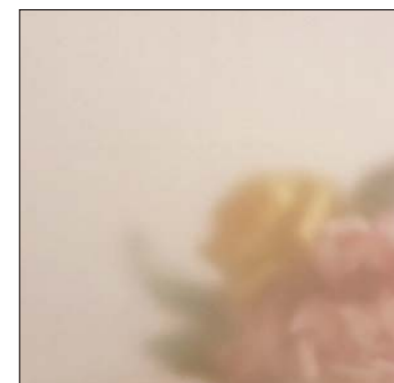

SG-C04 (5mm)

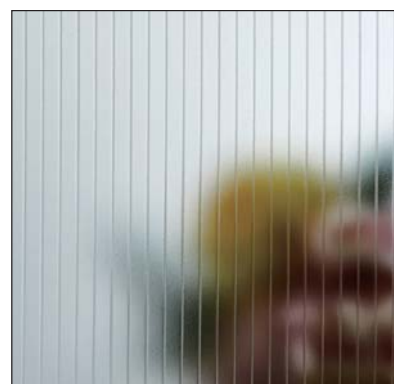

클리어라인 (5mm)

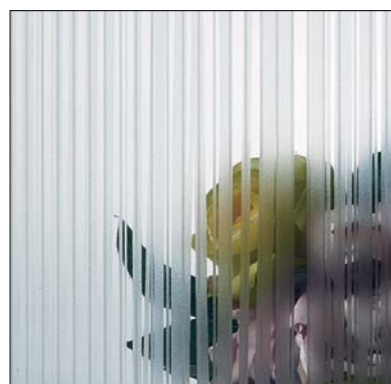

클리어지브라 (5mm)

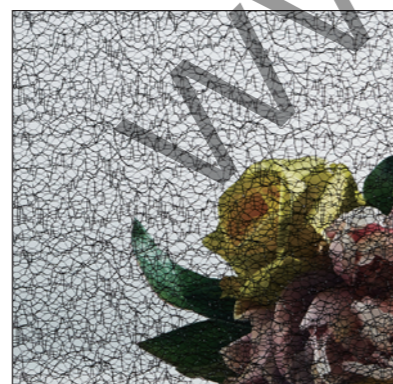

네트유리 (8.2mm)



한지접합 (8.2mm)



SG-F01 (5mm)



SG-F02 (5mm)



SG-F03 (5mm)



SG-F04 (5mm)

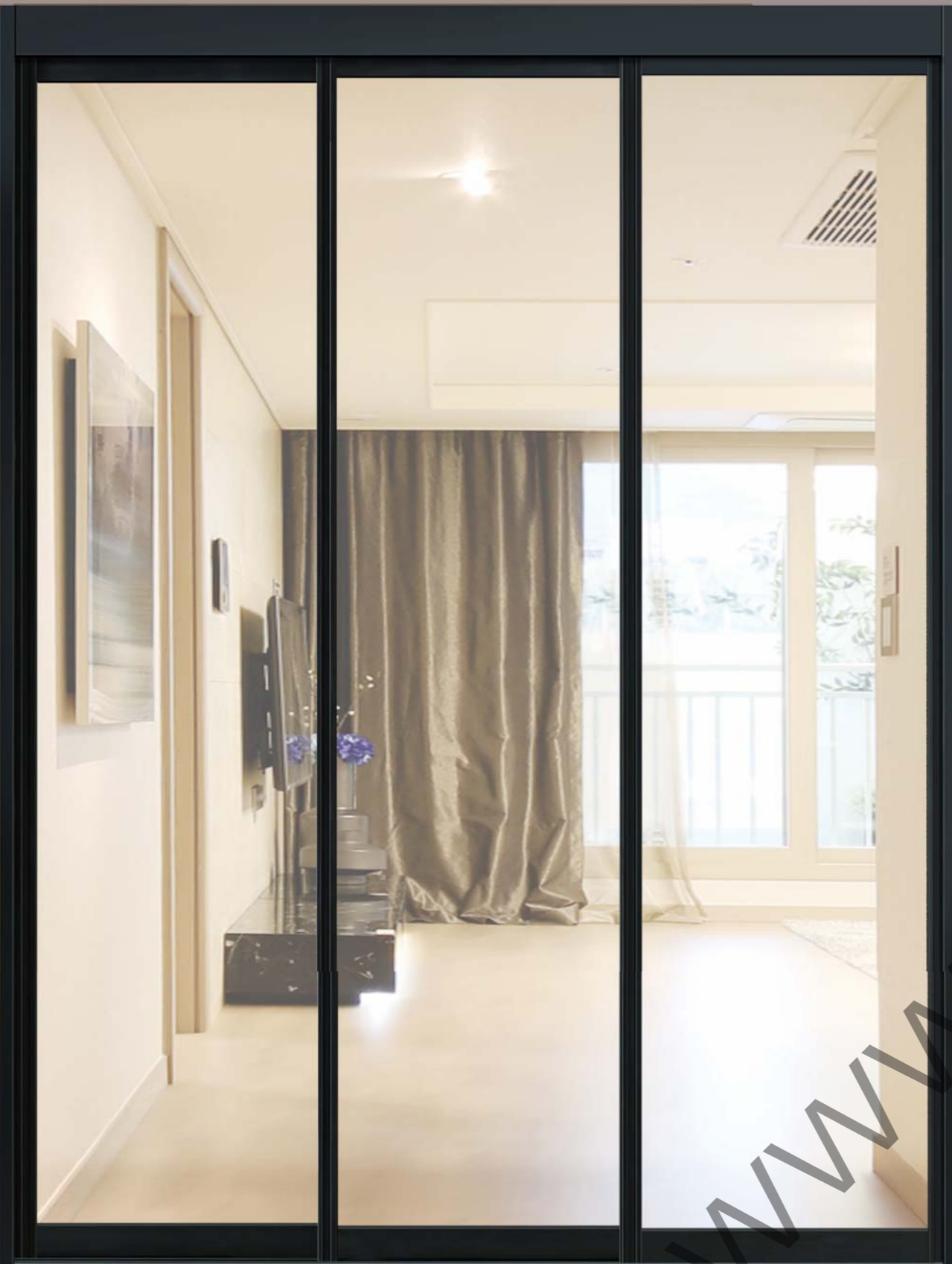

SUNWOOD 알루미늄 슬림 시스템

* 상기 이미지는 이해를 돕기 위한 이미지입니다.

알루미늄 슬림 시스템

모던하고 세련된 디자인의 선우드 알루미늄 슬림도어...

공간을 재구성하여 새로운 공간을 창조해냅니다.

현관, 주방, 거실, 침실, 드레스룸 등 다양한 공간 형태에 따라 맞춤형으로 설치하여 집안 어느곳에서나 완벽하게 어우러집니다.

선우드 알루미늄 슬림도어 특징점

- 도어 프레임이 슬림하여 개방감이 극대화되고 심플하고 모던한 감각의 인테리어 효과를 연출합니다.
- 슬라이딩 도어는 안전 댐퍼를 도어 양쪽에 장착하여 문을 여닫을 시 손끼임으로 인한 부상 방지와 강한 힘으로 문을 닫을시에도 충격으로 인한 파손의 우려가 없습니다.
- 도어 프레임의 슬림화로 기존 문의 두께로 설치가 어려운 장소에도 설치할 수 있어 설치 장소 제한의 영향을 덜 받습니다.
- 본 제품은 불소도장 제품으로 도장이 잘 벗겨지지 않으며 무광의 고급스러운 색상이 인테리어 효과를 극대화 시킵니다.
- 여닫이 도어에 적용된 도어 핸들은 독일 제품을 적용하여 모던한 감각과 견고함을 강조하였으며 잠금장치 적용으로 안전과 감각적인 인테리어 효과를 극대화 하였습니다.

운영 모델 | 3연동, 원슬라이딩, 양개/편개 여닫이

슬림도어 (원슬라이딩)



슬림도어 (여닫이)



시공사례



* 시공 별도 문의 바랍니다.

행거철물



접이철물

제품 특징

- 두짝 문이나 그 이상의 접이문을 설치하는데 사용하는 제품입니다.
- 마모성에 강한 아세탈 롤러를 사용하였으며 소음이 적고 유격이 없는 견고한 고강도 베어링을 사용하였습니다.

제품 세트 구성

상부레일, 하부레일, 상부롤러, 하부가이드, 상부 고정피봇, 접이식경첩(문과 문 사이에 4개씩)

제품 설치 시 주의사항

- 1 상부, 하부레일을 각각 설치 후 고정문의 상, 하부에 상부고정 피봇세트를 설치합니다.
(※ 상부고정피봇설치시 상부레일에 상부고정피봇을 고정시킵니다.)
- 2 상부고정 피봇의 상, 하부 문측 타공은 문측 타공거리는 문짝 크기에 따라 다릅니다.
- 3 접이식도어 폴딩타입은 짝수(한방향최대4짝)로만 제작가능 / 폴딩-슬라이딩 타입은 홀수로도 제작가능
- 4 도어폭 550mm 이상은 권장하지 않습니다
- 5 설치시 수평,수직 레벨을 반드시 맞춰야합니다.

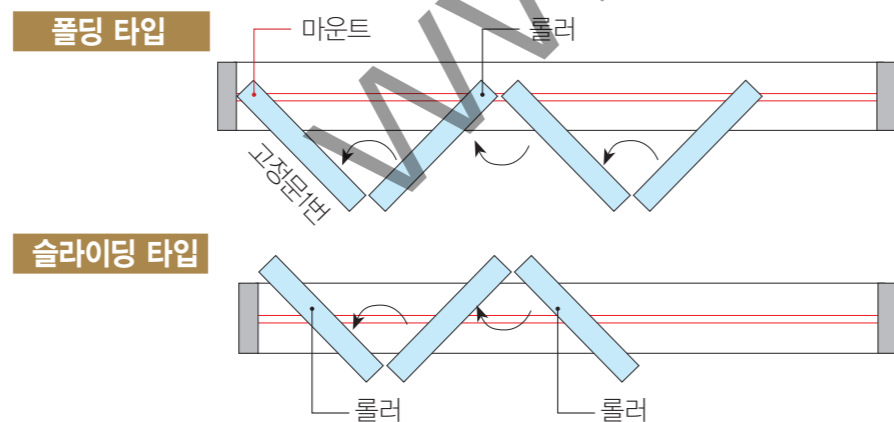

노출형 행거

벽면에 바로 시공하여 공간 효율성을 높인 스타일리쉬한 인테리어 아이템.



SUNWOOD 노출형 행거

- 벽면에 바로 시공하여 문틀 시공이 어려운 곳에서도 설치 가능합니다.
- 벽면에 고정되어야 하므로 도어 하중을 견딜 수 있는 콘크리트 벽체나 보강된 벽체에 시공해야 합니다.
- 하부 가이드와 도어 이탈 방지용 하드웨어로 흔들림이 적고 안전합니다.
- 상부 고정(Up) 타입과 상부 타공 고정(Front) 타입 두 가지로 원하는 디자인 선택이 가능합니다.
- 댐퍼 작용으로 더욱 편하게 사용 가능합니다. (옵션 사항)

하드웨어 (HARDWARE)

도어손잡이 | Door Lock



HLP-S01



HLP-S02



HLP-S03



HLP-A01



HLP-A02 [KEY TYPE 운영]



HLP-A03 [KEY TYPE 운영]



HLP-A04



HLP-A05



HLP-A06



HLP-A07



HLP-A08



HLP-A09



HLP-A10



HLP-H01



HLP-H02



HLP-H03



HLP-H04



HLP-H05



HLP-H06

모티스락 | Mortise Lock



HLM-S01



HLM-S02



HLM-S03

방화문용 | Fire rated door



HLP-F01



HLP-F02



HLP-F03



HLP-F04



모티스락바디 + 프로파일 실린더

풀핸들 | Pull Handle



HPH-001S (스텐) 340MM/25 ♯ HPH-001B (블랙) 340MM/25 ♯

슬라이딩락 | Sliding Lock



HDP-001(동전형) HDP-001(열쇠형)

푸쉬풀락 | Push-Pull Lock



HPP-001

기타부자재 | Hardware



HDR-001 [오목손잡이] HDR-002 [오목손잡이] HDG-001 [오목손잡이] HEG-001 [엣지풀] HER-001 [엣지풀]
 HHE-001 [이지경첩] HHG-001 [나비경첩] HHE-F45 [방화경첩] HSR-001 [릿지받이 조절타입] 방화문용 패드

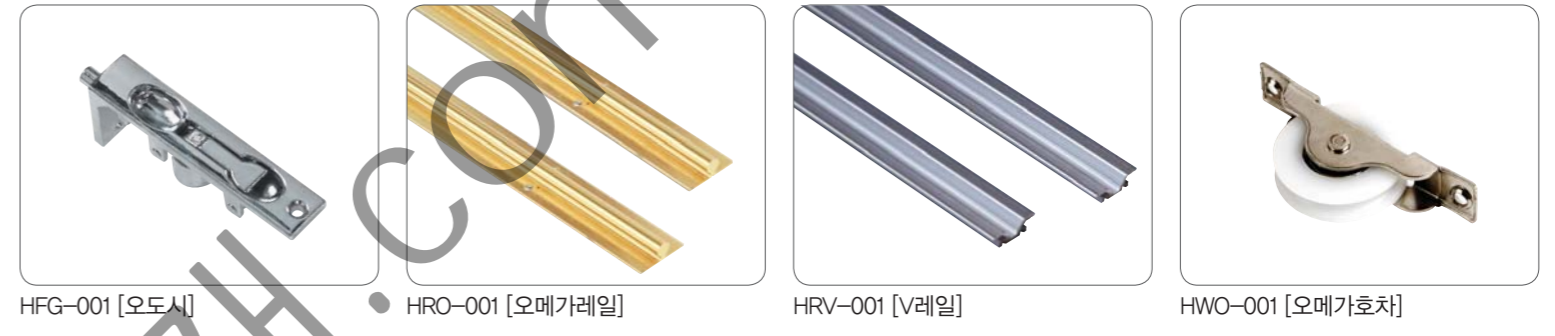

HFG-001 [오도시] HRO-001 [오메가레일] HRV-001 [V레일] HWO-001 [오메가호차]



연동호차 HBG-001 [범퍼] HIC-001 [조명확인창]



HVG-001 [환기캡] HSL-001 [도어스톱] HSL-002 [도어스톱]



HSL-003S [실버] HSL-003W [화이트] 연성메폼제 (* 재고 10가지 색상 운영) HD 600R [방화문용 도어클로저]

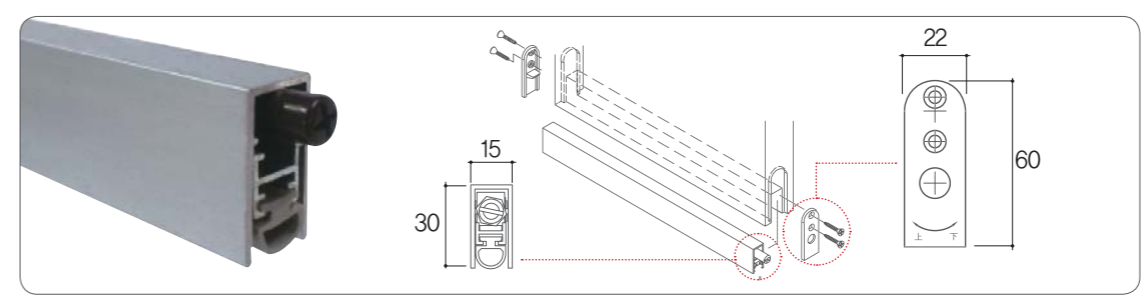

오도시 ※ 833/933 두가지 사이즈만 운영합니다.



선우드 몰딩은
일류상품으로 선정된
우수자재를 사용합니다.



일류상품 선정
관련기사

걸레받이 | Base Moulding



강화걸레받이 | 80×15



걸레받이 | 80×9

루버 | Louver

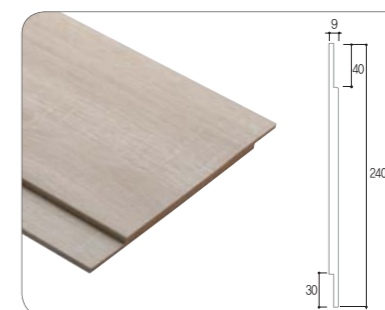

루버240 | 240×9



루버380 | 380×9

마감 몰딩 | Finish Moulding

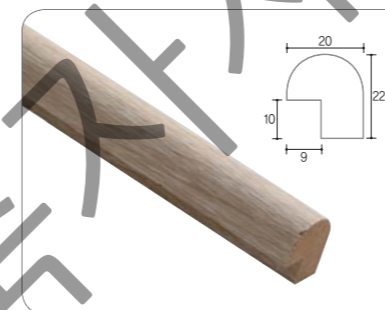

마감재 | 22×20

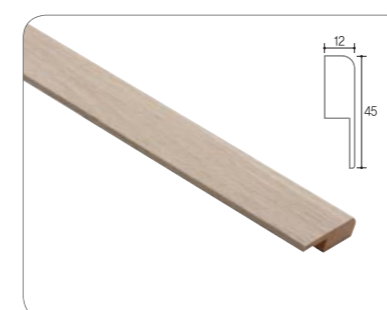

루버마감45 | 45×12



루버마감80 | 80×12

마이너스 몰딩 | Inside Moulding

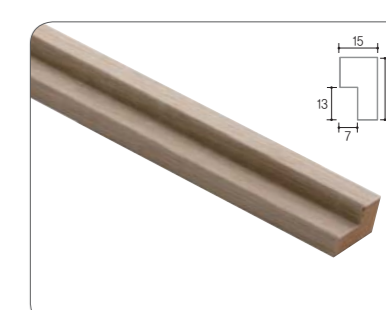

마이너스 | 25×15

계단 몰딩 | Step Moulding

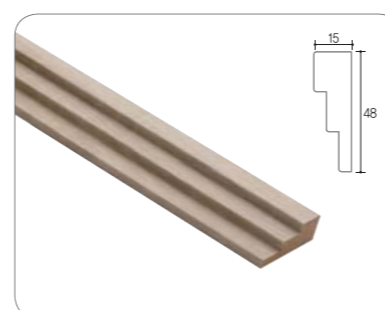

3계단 48 | 48×15

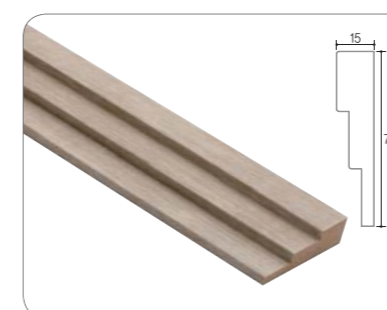

3계단 70 | 70×15

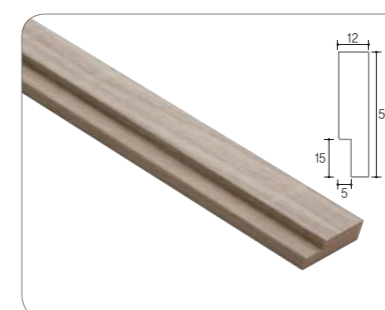

2계단 50 | 50×12

코너머리기둥 | Corner Moulding



코너머리기둥(대) | 138×138×140



코너머리기둥(소) | 103×103×140

평 몰딩 | Flat Moulding



평 30	30×2,440×9	평 150	150×2,440×9
평 40	40×2,440×9	평 200	200×2,440×9
평 60	60×2,440×9	평 250	250×2,440×9
평 80	80×2,440×9	평 300	300×2,440×9
평 100	100×2,440×9	평 400	400×2,440×9
평 120	120×2,440×9	평 600	600×2,440×9



몰딩 (MOULDINGS)

천정 몰딩 | Ceiling Moulding

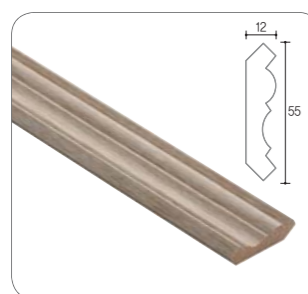

천정55 | 55×12

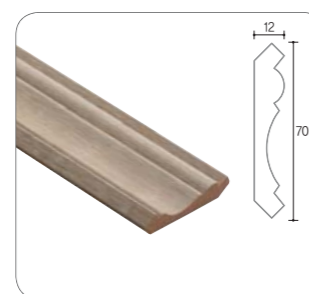

천정70 | 70×12

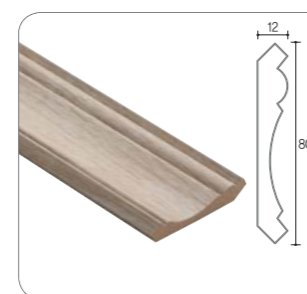

천정80 | 80×12



천정90 | 90×12

코너 몰딩 | Corner Moulding

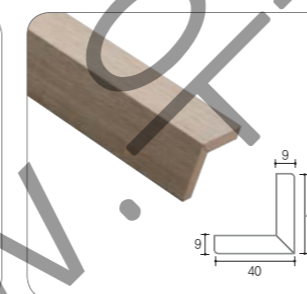

코너40 | 40×40×9

문선 | Architrave

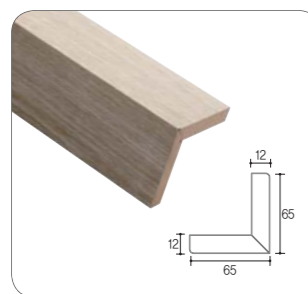

코너65 | 65×65×12

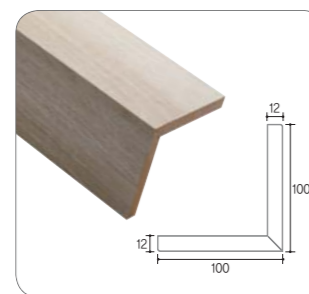

코너100 | 100×100×12



문선58 | 58×15

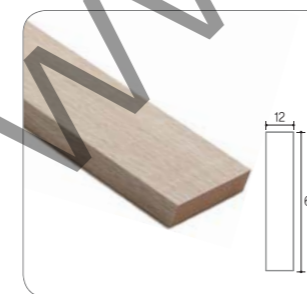

문선60 | 60×12

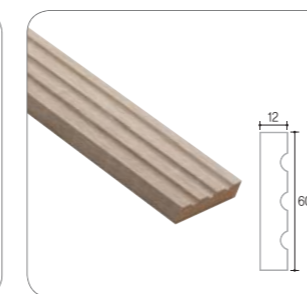

라인문선 | 60×12



합판 루버 (PANEL COLLECTION)

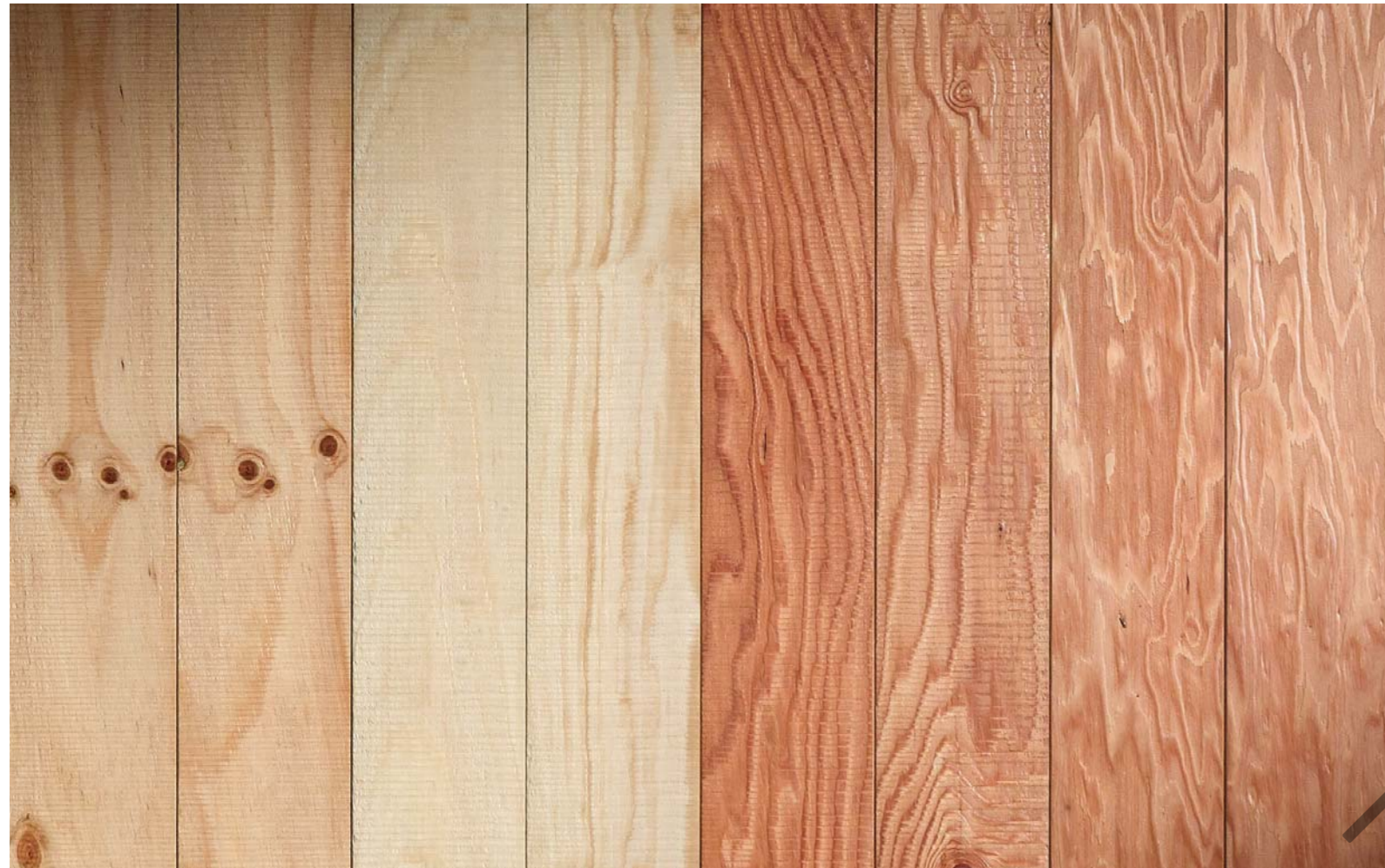

규격 : 118X2440X7.5T 포장단위 : 12EA/BOX(1평)
200X2440X7.5T 7EA/BOX(1평)

합판 보드, MDF 보드, 뉴송각재



공간에 어울릴 수 있도록 다양한 보드를 선보이는 선우드 - 최상의 제품만을 엄선합니다.

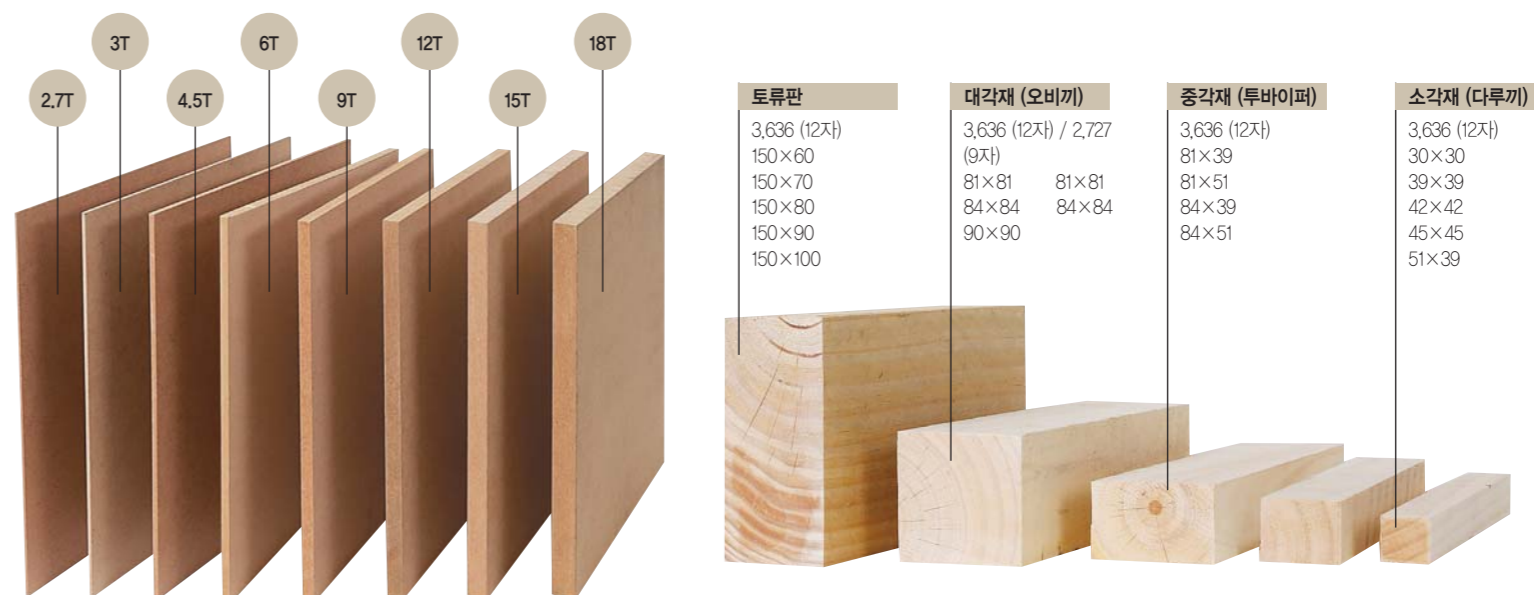

선우드 리그노방화문은 앞서가는 기능성으로 다양한 공간에 맞는 기능별 제품군을 구성하고 있습니다

SINGLE SWING DOOR (편개문)



FWD 30
FWD 60
FWD 90(BS)



Wood Frame / Steel Frame

- 목재문틀 or 철재문틀 선택 가능
- 표면마감재 : SHEET, 천연무늬목, 도장(철재문틀), 백골
- 도어두께 : 47~60mm 기준
- 문틀규격 : 100~300mm(비규격주문가능)
- 도어두께 : 46~55mm
- 문선 램마 타입은 별도 옵션 주문 가능

Door / Wood

- 표면소재 : 합판 OR HDF
- 표면마감재 : SHEET, 천연무늬목, 도장, 백골
- 기본두께 : 47mm~60mm(비규격주문가능)
- 디자인 : 기본 민자형, 다양한 인테리어 목재도어 디자인 가능
- 옵션 : 방음성능 하부 AUTO BOTTOM SILL 및 부착가공 하드웨어

Hardware / 옵션 ※방화인증 제품을 사용해야 합니다.

- NO SILL TYPE / AUTO BOTTOM SEAL
- BUTT HINGE / 4x4.5 / Stainless Steel
- 방화도어록 / Mortise / Cylinder / Lever TYPE
- DOOR CLOSER

VISION PANEL SWING DOOR (유리방화문)



FWD V30(BS)
FWD V60(BS)

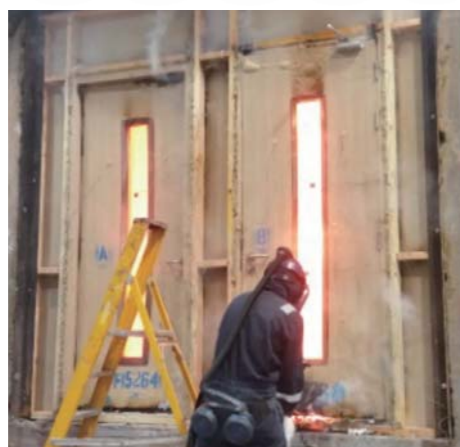

Wood Frame

- 목재문틀 or 철재문틀 선택 가능
- 표면마감재 : SHEET, 천연무늬목, 도장(철재문틀), 백골
- 하부SILL : 4면 일체형, 재료분리대, SUS, SILL 없음
- 도어두께 : 47~60mm 기준
- 문틀규격 : 100~300mm(비규격주문가능)
- 문선 램마 타입은 별도 옵션 주문 가능

Door / Wood

- 표면소재 : 합판 OR HDF
- 표면마감재 : SHEET, 천연무늬목, 도장, 백골
- 기본두께 : 47mm~60mm(비규격주문가능)
- 디자인 : 기본 민자형, 다양한 인테리어 목재도어 디자인 가능
- 옵션 : 방음성능 하부 AUTO BOTTOM SILL 및 부착가공 하드웨어
- 방화유리 : 두께 8T [200x1,700 인중]

Hardware / 옵션 ※방화인증 제품을 사용해야 합니다.

- No SILL TYPE / AUTO BOTTOM SEAL
- BUTT HINGE / 4x4.5 / Stainless Steel
- 방화도어록 / Mortise / Cylinder / Lever TYPE
- DOOR CLOSER

DOUBLE SWING DOOR (양개문)

FWD D30(BS)
FWD D60(BS)



Wood Frame

- 목재문틀 / 스토퍼 일체형 /분리형 선택 가
- 표면마감재 : SHEET, 천연무늬목, 도장(철재문틀), 백골
- 하부SILL : 4면 일체형, 재료분리대, SUS, SILL 없음
- 도어두께 : 52~60mm 기준
- 문틀규격 : 100~300mm(비규격주문가능)
- 문선 램마 타입은 별도 옵션 주문 가능

Door / Wood

- 표면소재 : 합판 OR HDF
- 표면마감재 : SHEET, 천연무늬목, 도장, 백골
- 기본두께 : 52mm ~ 60mm(비규격주문가능)
- 디자인 : 기본 민자형, 다양한 인테리어 목재도어 디자인 가능
- 옵션 : 방음성능 하부 AUTO BOTTOM SILL 및 부착가공 하드웨어

Hardware / 옵션 ※방화인증 제품을 사용해야 합니다.

- No SILL TYPE / AUTO BOTTOM SEAL
- BUTT HINGE / 4x4.5 / Stainless Steel
- 방화도어록 / Mortise / Cylinder / Lever TYPE
- DOOR CLOSER

방화용 하드웨어



선우드 리그노 방화문은 일반 목도어 디자인과 매칭하여 다양한 디자인 연출이 가능합니다.

I 기능성제품 (FUNCTIONALITY)

우수한 방염성능 검증결과를 획득한 SUNWOOD 방염몰딩은 완벽한 방염성으로 불에 잘 타지않고, 유독가스 발생이 적습니다.

방염이란?

화재위험이 높은 목재(MDF,합판)등에 방염을 처리하여 화재가 발생했을 시에 화재의 위험으로부터 피할 시간을 만들어주는 것이 방염처리의 목적입니다.

우수한 방염성능 시험을 획득한 선우드 방염몰딩

소방법, 건축법에 따라 특수장소 및 다중이용 매장등에서는 내연마감재를 필수적으로 사용하여 합니다. 선우드 방염제품은 우수한 방염성능으로 화재 발생시 잘 타지 않고 유독가스 발생이 적어 친환경적인 제품입니다. 기존의 방염제품의 난연접착제를 사용하여 만든 제품에 비해 보드 자체에 방염처리를 하여 화재에 강해 타사 제품보다 더욱 안전합니다.

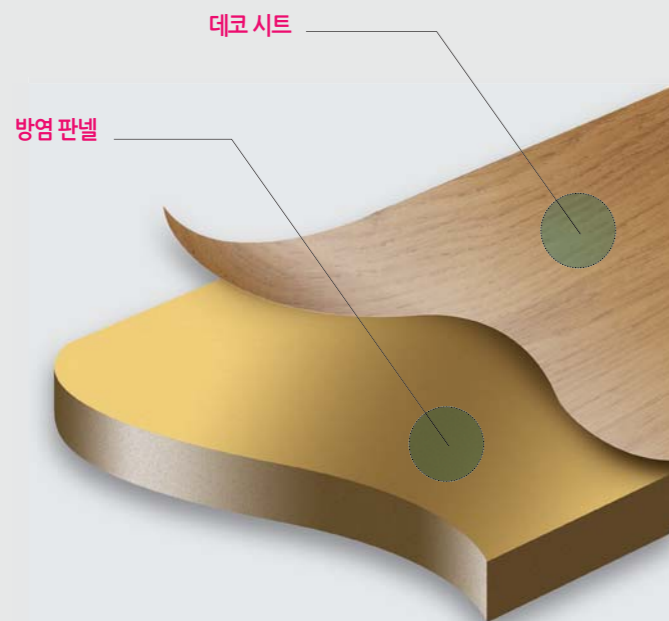

선우드 방염 몰딩

제품 : 평몰딩(10전 이상), 루바

선우드 방염 도어



DFA-001

DFA-S06

방염 몰딩 성능테스트



방염 선우드제품 (점연 120초 후)

일반 선우드제품 (점연 120초 후)

방염몰딩

한국소방검정공사 성능 시험

항목	기준	판넬+데코시트
잔염시간	10초 이내	0.0초
잔신시간	30초 이내	0.0초
탄화면적	50cm ² 이내	25cm ²
탄화깊이	20cm ² 이내	7.7cm ²

• 잔염시간 : 불꽃을 제거한 때부터 불꽃을 올리며 연소하는 상태가 그칠 때까지 시간
 • 잔신시간 : 불꽃을 제거한 때부터 불꽃을 올리지 않고 연소하는 상태가 그칠 때까지 시간
 • 탄화면적 : 불꽃에 의해 탄화된 면적 • 탄화깊이 : 불꽃에 의해 탄화된 깊이

방염 흡음판 | Sound-absorption Board

독특한 선형이 주는 시각적인 매력과 기능성이 복합적으로 작용하여 실내공간에 가치를 더하여 줍니다. (일반형,라인형,2중타공형 운영)

라인형(Line Type) 사이즈 : 1220mm(W)×2400mm(L)×9, 12, 15(T)



중심재질	T=15mm MDF/Density 720kg/m ³			제품단면구조					
	마감	무늬목	Painting	Deco sheet	무늬목	Painting	Deco sheet		
Standard Type W=192 or W=256		Special	3600mm (Nax)	3600mm (Nax)	3600mm (Nax)	마감면	① 투명우레탄락카 ② UV Coating ③ 건식 또는 습식 무늬목	① 지장색 우레탄 락카 ② UV Coating	① 지장 Deco Sheet
		Normal	240mm	240mm	240mm		④ T=15 or 18mm MDF	③ T=15 or 18mm MDF	② T=15 or 18mm MDF
Option Type (주문제작) W=300~1216		Special	3600mm (Nax)	3600mm (Nax)	3600mm (Nax)	중심면	④ T=15 or 18mm MDF	③ T=15 or 18mm MDF	② T=15 or 18mm MDF
		Normal	240mm	240mm	240mm		후면	⑤ B급 무늬목 ⑥ Acoustic Fleese	④ UV Coating(습선) ⑤ Acoustic Fleese

※표시된 규격은 원자재 수급사정에 따라 예고없이 변경될 수 있습니다.
 ※최대 가공 사이즈는 표면재질에 따라 변화됩니다. 설계시 문의하여 주십시오.

※표시된 단면구조는 당시의 개발사정에 의하여 변경될 수 있습니다.
 ※가급적 Design Module을 일치 시키는 것이 Cost면에서 유리합니다.

2중 타공형(Double Holes Type) 사이즈 : 1220mm(W)×2440mm(L)×9, 12, 15(T)

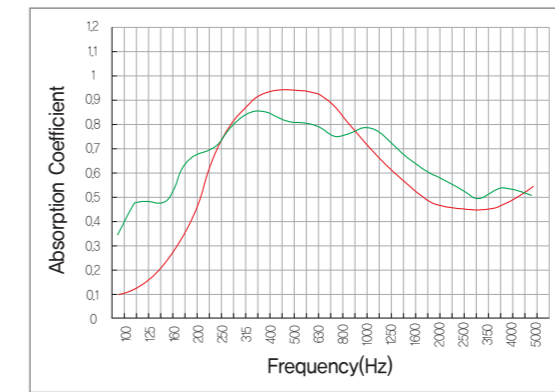

시공이미지

방사선 차폐도어(납문)

안전한 선우드 방사선 차폐도어는 병원 및 방사선(X-선) 시설에서 발생하는 방사선과 X-선을 차폐하기 위하여 설치하며, 벽체면의 방사선 차폐 안전기준에 맞게 제작 설치하며, 여닫이 또는 슬라이딩 형으로 제작이 가능합니다.



DPA-001

합판 도어

합판자체의 자연스러운 나뭇결을 살릴 수 있으며, 적용되는 현장의 특성에 따라 자유롭게 도장마감이 가능한 도어입니다.



DVA-001 : 합판백골

낙엽송 도어

100% 국내산 원목을 사용한 제품으로 2중 브러싱 가공을 하여 특유의 무늬결을 입체적으로 표현하며, 한국적인 색상과 여유있는 무늬결의 고급 인테리어 제품입니다.



낙엽송 민자 도어

기능성제품 (FUNCTIONALITY)

180~220℃의 고온압착 방식에 의한 3단계 특수작업 공정을 통해 생산되어지는 고열처리 원목도어는 날씨의 변화에 매우 강하게 설계되었고, 인간과 환경을 고려한 친환경 소재를 채택하여 소비자와 구매자에게 최고의 만족과 퀄리티를 보장합니다.

탄화목재 도어 Thermo Wood



DTH-002



DTH-003

Thermo Wood (써모우드) 란 180~220℃의 고온압착 방식에 의한 3단계 특수작업 진행 공정을 통해 생산되어지는 원목도어를 말합니다. 선창 ITS 선우드 만의 Thermo Wood 제작 공정을 통해 제작될 목재들은 그 목적에 맞는 특성으로 변화되어집니다. 각각의 3단계 공정을 거치면서 목재들은 썩거나 부패하지않는 반부패성, 부식되지않는 반부식성 그리고 안정성을 향상시킵니다. 이외에도 우리의 몸에 해롭지 않고 친환경적인 제품을 생산하기 위한 열과 증기 측정 생산방식을 진행하고 있습니다. 탄화목재 생산공정 중에는 생산목재의 색상이 변화하고 향미로운 나무의 구운냄새가 납니다. 또한 생산목재의 표면색상의 변화 뿐만 아니라 목재안쪽 부위도 변화를 겪게되는데 이러한 열로 인한 변화과정 등이 모두 실생활의 사용에 있어서 인간의 몸에 매우 유익 한 큰 장점으로 이어지기 때문입니다.

고강도 원목 사용 Solid Timber Doors



Thermo Wood Color

Temperatural Grilled Color Variations



기능성제품 (FUNCTIONALITY)

SUNWOOD 욕실용 제품은 습기가있는 공간에도 하자 없이 사용할 수 있으며, 청소가 용이한 기능성 제품입니다.

욕실용 마감재 (렉스판) Bathroom Finishing PVC Board



규격	포장단위
300×8자	9 (2평)
300×10자	7 (2평)
300×12자	6 (2평)



다이아몬드

자개

이음몰딩 15(W)×13(H)

PVC몰딩 색상칩

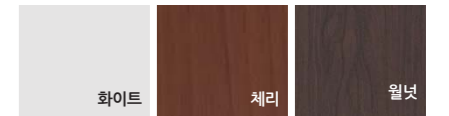

* 인쇄된 색상은 실제 색상과 다를 수 있습니다.

욕실용 마감재 (PVC몰딩) Bathroom Finishing PVC Moulding

SIZE: (W)×(H)



505 중 (화이트,체리,월넛) 45×22

504 (화이트) 35×20

문선 (화이트,체리,월넛) 45×18

카드 (화이트,체리,월넛) 30×30

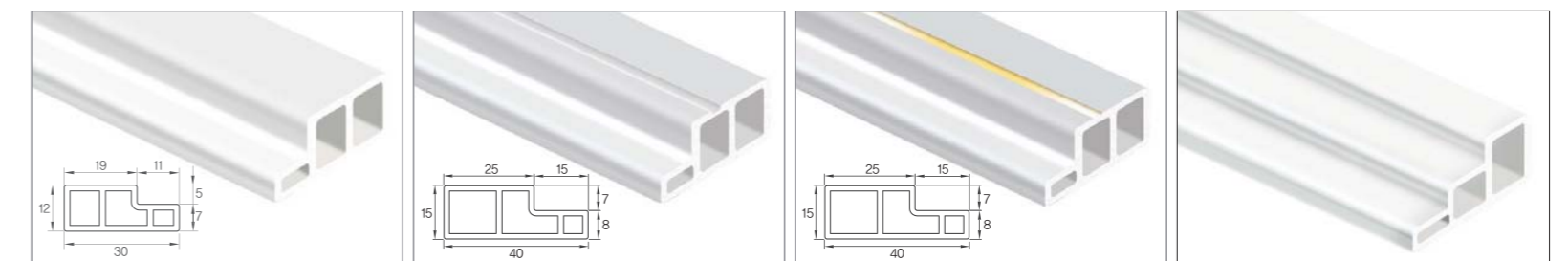

2계단 소 (화이트) 30×12

2계단 중 (화이트) 40×15

2계단 중 (금박) 40×15

3계단 (화이트,체리,월넛) 45×15

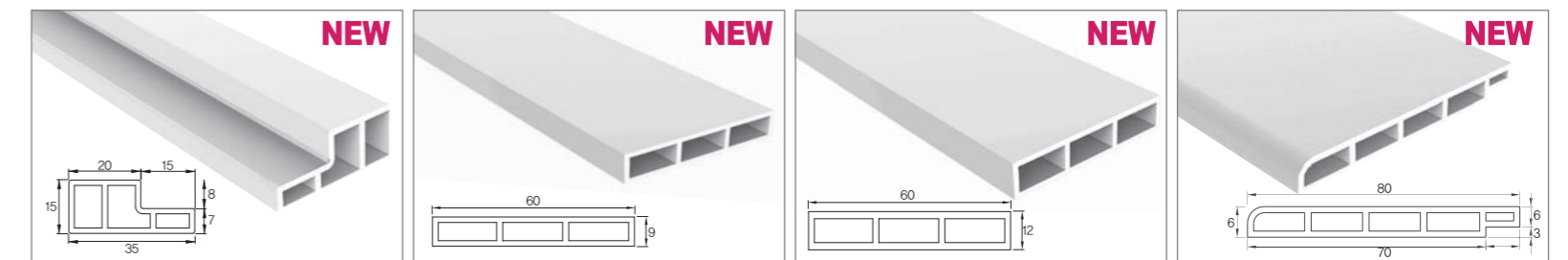

2계단 (화이트) 35×15

평 (화이트) 60×9

평 (화이트) 60×12

걸레받이 (화이트) 80×9

* PVC(화이트)몰딩 램핑 불가능합니다.

선우드 발코니 선반

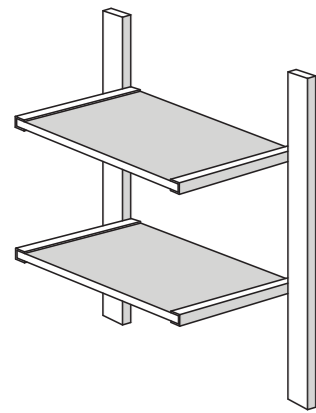

[운영색상] SUN-178



[발코니 선반 사이즈]
600(W) X 350(D)
800(W) X 350(D)

설치사례

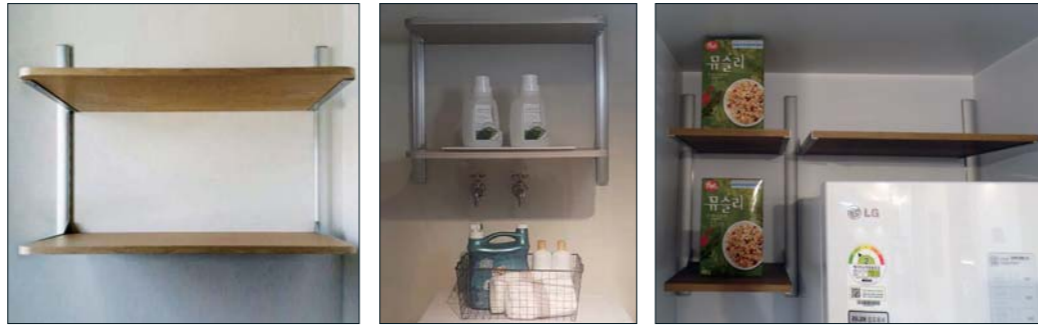

설치 매뉴얼

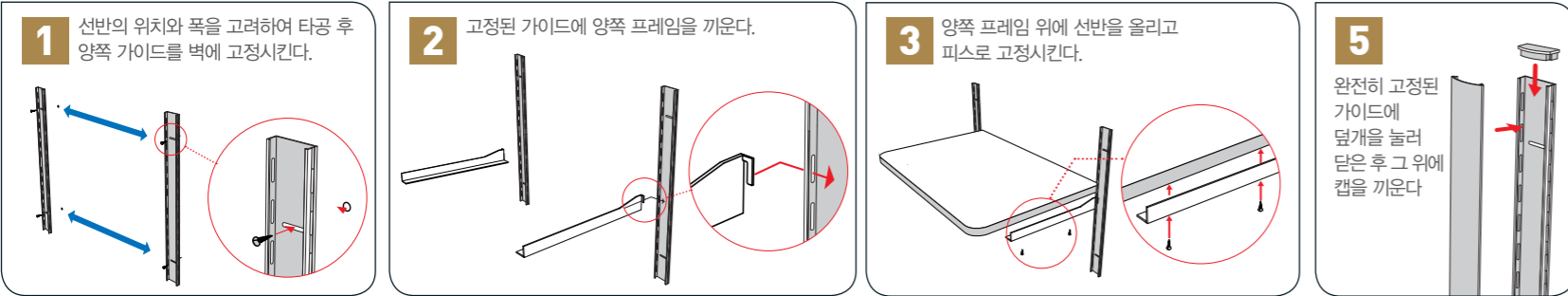

* 목재 특성상 휨현상이 발생 할 수 있습니다. * 옛지는 유사색으로 운영됩니다.

선우드 주문가구 (CUSTOM-MADE FURNITURE)

불박이장에서 시스템키친, 드레스룸, 다양한 수납장까지 ...
고객의 취향과 원하는 스타일에 딱 맞춘 가구제작을 통해 고객만족을 넘어 행복까지 가득 채워드립니다

Kitchen Sink, Kitchen Hood, Kitchen Cooktop, Chair/Table, Dishwasher, Dishdryer, Accessories와 다양한 표면마감재 등 선우드 가구만의 기술력과 노하우로 고객
이 원하는 스타일의 인테리어를 제공해 드립니다.



선우드 시스템 가구

수납 공간 활용은 극대화, 편리하게 사용 가능한 라이프 스타일 시스템 가구.
선우드 시스템 가구는 고객이 원하는 품목으로 선택하여 다양하게 구성할 수 있습니다.
수납 공간을 최대한 활용할 수 있는 시스템이며 다양한 구성을 선택하여 드레스룸은 물론
발코니 등에서도 편리하게 수납 가능한 시스템입니다.
작은 공간에서 큰 공간까지 원하는 스타일로 고객맞춤 서비스를 제공합니다.

[운영색상] SUN-178



모델명	포스트	코너포스트	선반800	선반600	선반400	코너선반	옷봉
규격	L=2,300	L=2,300	800(W) X 400(D) X 18(T)	600(W) X 400(D) X 18(T)	400(W) X 400(D) X 18(T)	800(W) X 800(D) X 18(T) 변경수치	
기본 형태							

모델명	2단 서랍 (고정형/이동형)	3단 서랍 (고정형/이동형)	3단 서랍 [1단 액세서리] (고정형/이동형)	ACC/바지걸이 서랍 (고정형)	ACC서랍 (고정형)	바지걸이서랍 (고정형)
규격	600/800(W) X 400(D) X 398(H)	600/800(W) X 400(D) X 578(H)	600/800(W) X 400(D) X 578(H)	600/800 (W) X 400(D)	600/800(W) X 400(D)	600/800(W) X 400(D)
기본 형태			5T 브론조유리 액세서리함 			

*배송 및 설치 별도 문의

모듈구성

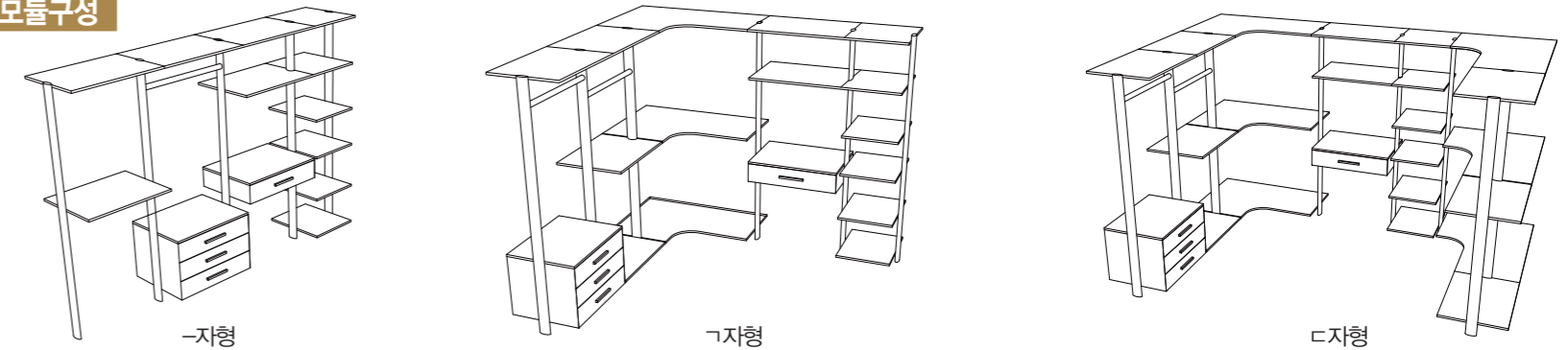

설치사례





※ 상기 이미지는 이해를 돕기 위한 이미지입니다.

H613 [화이트 워시오크]

Oak Flooring

밝고 고급스런 오크 무늬결이 돋보인다
 고급스러운 오크무늬결로 공간을 밝고 화사하게 꾸며줍니다.



H611 [워시오크]

H612 [스위트오크]

H613 [화이트 워시오크]

H614 [화이트오크]

규격 : 95 X 800 X 7.5
 [1 BOX = 3.3㎡]



* 상기 이미지는 이해를 돕기 위한 이미지입니다.

H615 [라이트오크]

Light Flooring

은나노로 건강까지 디자인하다

친환경 은나노 항균기능으로 건강하게 소비자의 마음까지 디자인합니다.

규격 : 95 X 800 X 7.5
[1 BOX = 3.3㎡]



H615 [라이트오크]

H616 [내추럴애쉬]

H617 [오크브라운]

H618 [오리진오크]

H619 [스노우오크]

다이아 아트월은 깔끔한 디자인으로 공간을 더 빛나게 해 줍니다.



* 상기 이미지는 이해를 돕기 위한 이미지입니다. * 제품이미지와 색상의 차이가 있을 수 있으므로 샘플북을 참조하십시오.

●아트월 SUN-007 + SUN P02(포인트) ●벽판넬 WPS-016(푸어우드) ●도어 DAS-024(P)

크리스탈을 포인트로 사용하여 입체감과 모던함이 생생하게 느껴집니다.



* 상기 이미지는 이해를 돕기 위한 이미지입니다. * 제품이미지와 색상의 차이가 있을 수 있으므로 샘플북을 참조하십시오.

●아트월·등박스 SUN-007 + SUN 001(포인트-재고운영색상) ●벽판넬 WPS-053(스모키스톤) ●도어 DLE-001(PON-J01)

다이아II 아트월 [AMB-004]

기본단위 (1set)
기둥 2EA, 보 2EA, 보이음새 1EA

규격(단위 : mm)

기둥 : 210×2,440×65
보 : 210×2,440×65
보 이음새 : 150×219×74

아트월 상세컷

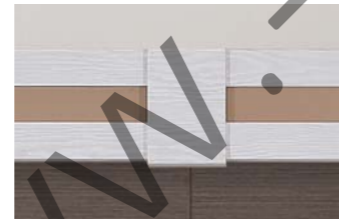

벽마감재



WPS-016 [푸어우드]

재고운영색상

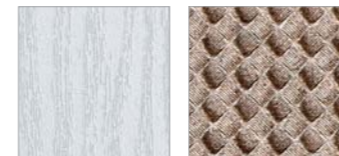

SUN-007

SUN-P02

스텔라 아트월 [AMB-003]

기본단위 (1set)
기둥 2EA, 보 1EA, 보이음새 1EA

규격(단위 : mm)

기둥 : 400×2,440×50
보 : 150×2,400×120
보 이음새 : 150×159×129

스텔라 등박스 [LMB-003]

기본단위 (1set)
등박스 프레임 4EA, 코너 프레임 4EA

규격(단위 : mm)

등박스 : 240×2,400×15
코너 프레임 : 290×290×25

아트월 상세컷

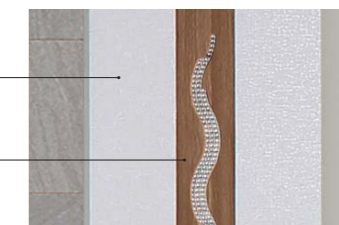

등박스 상세 도면

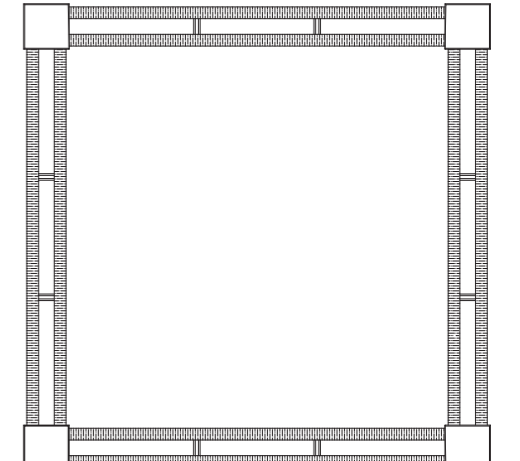

크리스탈 포인트



벽마감재



WPS-053 [스모키스톤]

주색상



SUN-007

재고운영색상 (포인트)



SUN-001

SUN-002

SUN-005

SUN-010

음각과 양각이 표현으로 볼륨감이 더 돋보이고 화려함이 살아있습니다.



※ 상기 이미지는 이해를 돕기 위한 이미지입니다. ※ 제품이미지와 색상의 차이가 있을 수 있으므로 샘플북을 참조하십시오.

●아트월 · 등박스 SUN-008 ●벽판넬 WPS-055 (라이트레더) ●도어 DAS-008

데이지 아트월 [AMC-001]

기본단위 (1set)
기둥 2EA, 보 2EA, 보 이음캡 1EA

규격(단위 : mm)
기둥 : 400×2,440×50
보 : 150×2,400×50
보 이음캡 : 150×159×59

데이지 등박스 [LMC-001]

기본단위 (1set)
등박스 프레임 4EA, 코너 프레임 4EA

추가품목
센터 프레임 4EA
규격(단위 : mm)
등박스 : 240×2,400×15
센터 프레임 : 280×150×25

아트월 상세컷



등박스 상세 도면

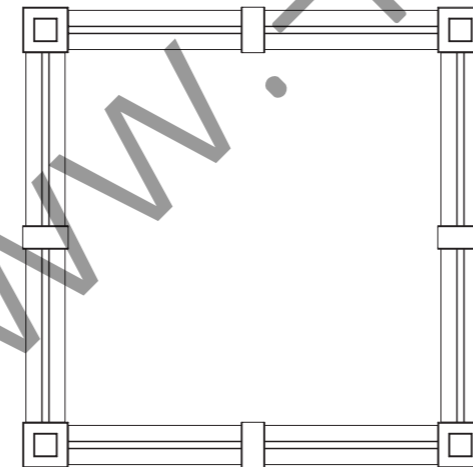

벽 마감재



WPS-055[라이트레더]

재고윤영색상



SUN-002 SUN-007 SUN-008 SUN-134 아이보리 곤죽판넬

PU원단 소재로 투톤작업을 해 고급스러움에 섬세한 기능까지 더합니다.



※ 상기 이미지는 이해를 돕기 위한 이미지입니다. ※ 제품이미지와 색상의 차이가 있을 수 있으므로 샘플북을 참조하십시오.

●아트월 · 등박스 SUN-108 + SUN P03(포인트) ●벽판넬 WPS-017(퀸애쉬) ●도어 DMB-S07

아델라 아트월 [AMB-001]

기본단위 (1set)
기둥 2EA, 보 2EA, 보 이음캡 1EA

규격(단위 : mm)
기둥 : 400×2,440×50
보 : 150×2,400×50
보 이음캡 : 150×159×59

아델라 등박스 [LMB-001]

기본단위 (1set)
등박스 프레임 4EA, 코너 프레임 4EA

추가품목
센터 프레임 4EA
규격(단위 : mm)
등박스 : 240×2,400×15
코너 프레임 : 290×290×25
센터 프레임 : 280×150×25

아트월 상세컷



등박스 상세 도면

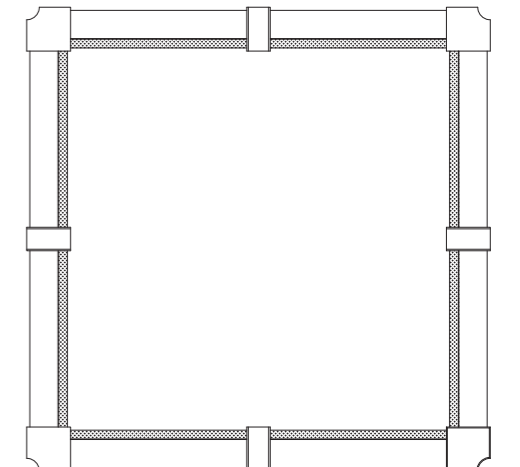

벽 마감재

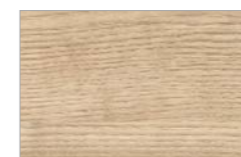

WPS-017 [퀸애쉬]

재고윤영색상



SUN-001 SUN-P03 SUN-002 SUN-P05 SUN-007 SUN-P01 SUN-108 SUN-P03 SUN-110 SUN-P05

고급스러운 엠보판넬에 백색필이 더해져 거실 분위기가 럭셔리해집니다.



* 상기 이미지는 이해를 돕기 위한 이미지입니다. * 제품이미지와 색상의 차이가 있을 수 있으므로 샘플북을 참조바랍니다.

●아트월·등박스 SUN-010 ●벽판넬 WPS-018(레인보우아카시아) ●도어 DLC-G01 (PON-G04)

모던하고 심플한 아트월로 따뜻하고 부드러운 분위기가 돋보입니다.



* 상기 이미지는 이해를 돕기 위한 이미지입니다. * 제품이미지와 색상의 차이가 있을 수 있으므로 샘플북을 참조바랍니다.

●아트월·등박스 SUN-002 ●벽판넬 WPS-011(블라스트시더) ●도어 DAS-026

벨라 아트월 [AMB-002]

기본단위 (1set)
기둥 2EA, 보 2EA, 보 이음캡 1EA

규격(단위 : mm)
기둥 : 350×2,440×50
보 : 150×2,440×120
보 이음캡 : 150×159×129

벨라 등박스 [LMB-002]

기본단위 (1set)
등박스 프레임 4EA, 코너 프레임 4EA

규격(단위 : mm)
등박스 : 240×2,400×15
코너 프레임 : 290×290×25

아트월 상세컷



등박스 상세 도면

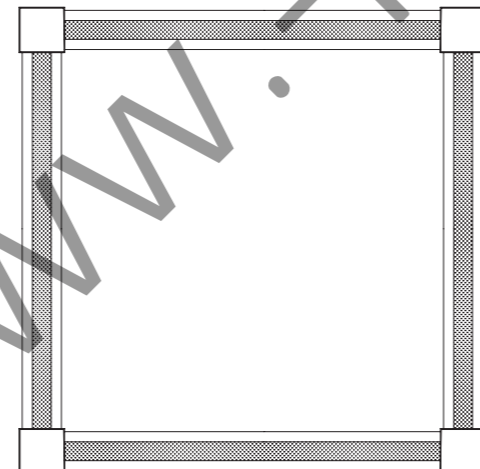

스퀘어 아트월 [AMA-001]

기본단위 (1set)
기둥 2EA, 보 2EA, 보 이음캡 1EA

규격(단위 : mm)
기둥 : 400×2,440×50
보 : 200×2,440×50
보 이음캡 : 150×209×59

스퀘어 등박스 [LMF-001]

기본단위 (1set)
등박스 프레임 4EA, 코너 프레임 4EA

추가품목
센터 프레임 4EA
규격(단위 : mm)
등박스 : 240×2,400×15
코너 프레임 : 290×290×25
센터 프레임 : 280×150×25

아트월 상세컷



등박스 상세 도면

